

Installation guide



Doorphone SC901AU / SC902AU / SC906AU
SC100AU
SC200AU / SC201AU / SC206AX
MHF01X / MHF02X
MHF03X / MHF04X
MHF05X / MHF06X



This manual describes how to install the following products:

SC901AU	Mains/mains code-operated 1-home doorphone kit
SC902AU	Lithium/mains 1-button 1-home doorphone kit
SC906AU	Battery/mains 1-button 1-home doorphone kit
SC100AU	Interior handset unit + base + EU power pack
SC200AU	Mains controller
SC201AU	Lithium battery-operated controller
SC206AX	Dry battery controller
MHF01X	Translucent 2-home outdoor caller unit
MHF02X	Translucent code-operated 2-home outdoor caller unit
MHF03X	Opaque 1-home outdoor caller unit
MHF04X	Opaque 2-home outdoor caller unit
MHF05X	Opaque code-operated 1-home outdoor caller unit
MHF06X	Opaque code-operated 2-home outdoor caller unit

Foreword

The doorphone system can be used to welcome and filter visitors, listen in to background sounds at each access point and communicate with another handset.

It can also be used to remotely control:

- one or several electrical latches,
- one or several automatic gate control systems,
- one or several automatic garage door control systems,
- one or several lights.

It also allows users to check the status of access points or lights using the screen on the handset at any time.

Several additional interior handset units can be added to the doorphone system (maximum of 4 per call button).

Contents

1. Introduction	4
2. Description	6
2.1 Outdoor system	6
2.2 Interior handset unit	7
3. Tooling required	11
4. Preparation	12
4.1 Guarantee stickers.....	12
4.2 Charging the handset before installation	13
5. Installing the outdoor system	16
5.1 Installing the outdoor caller unit	16
5.2 Installing the controller.....	21
5.3 Connecting the equipment.....	22
5.4 Powering the controller.....	24
5.5 Creating the radio link between the handset and the controller	28
6. Testing the radio range	31
7. Installing the interior handset unit	32
7.1 On a table.....	32
7.2 On a wall.....	32
8. Testing operation	36
8.1 Testing communication with each interior handset unit	36
8.2 Testing access controls	37
9. Appendices	38
9.1 General information about creating the radio link.....	38
9.2 Testing the radio link.....	55
9.3 Deleting radio links and returning to factory programming.....	57
10. Changing the batteries	61
10.1 In the main controller	61
10.2 In the handset	64
11. Questions – Answers	65
12. Technical data	67

DOORPHONE SYSTEM COMPONENTS

Outdoor caller units wired to main controller (road side)

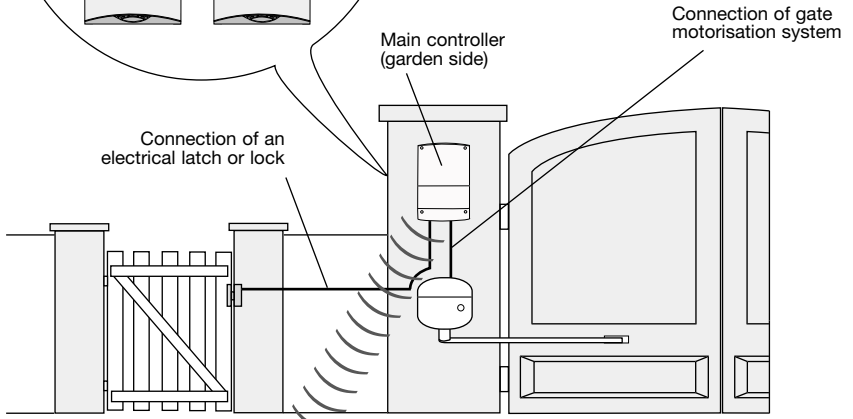
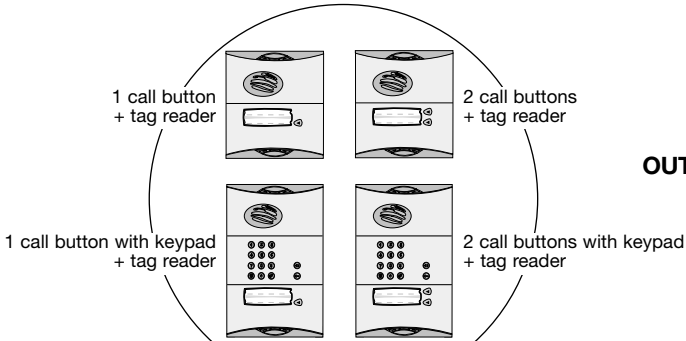

INTERIOR HANDSET UNIT

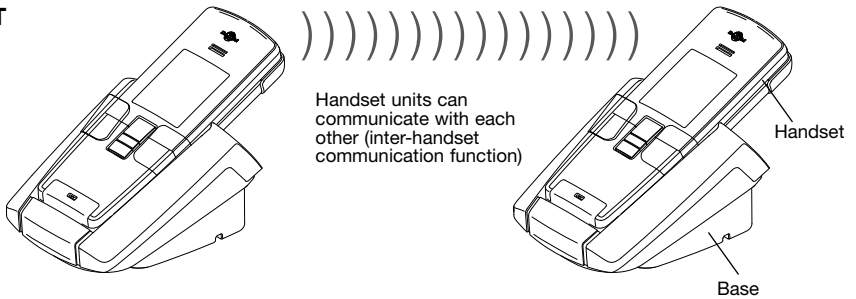

Each kit comprises the following (minimum):

- An outdoor caller unit installed on the road side, for visitors.
- A controller installed on the same pillar but on the garden side. This controller provides:
 - the radio link with the interior handset unit,
 - the power supply to the outdoor caller unit and controller,
 - the connections to the electrical lock or latch and gate motorisation system.These products are connected via a cable that either goes through or around the pillar.
- An interior handset unit (base and handset) for receiving calls and remotely controlling:
 - the electrical locks or latches,
 - the gate motorisation system,
 - the automatic garage door control system (1),
 - lighting (1),
 - communication with another handset (2),
 - doorphone programming.

Using the outdoor caller unit, access is controlled using:

- an access code,
- a tag reader.

Identifying each user with a tag

The outdoor caller units have a front panel with a tag reading zone allowing each user to control access quickly once the tag has been identified.

Holding the tag **up to the name** label dispenses the user from entering the access code.

The outdoor caller unit with keypad can manage up to 16 different tags. Each tag must be registered on the caller unit.

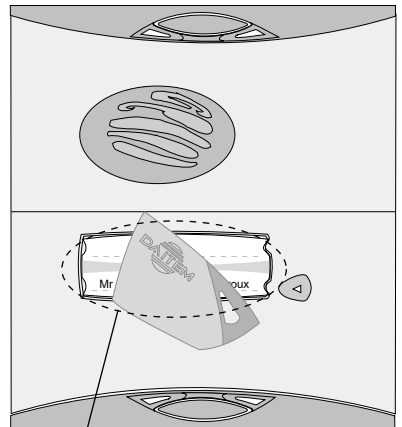

The tag is detected in this zone

1) Via output receiver.

2) Requires a minimum of 2 handsets.

2. Description

2.1 Outdoor system

2.1.1 Outdoor caller units with armoured cover

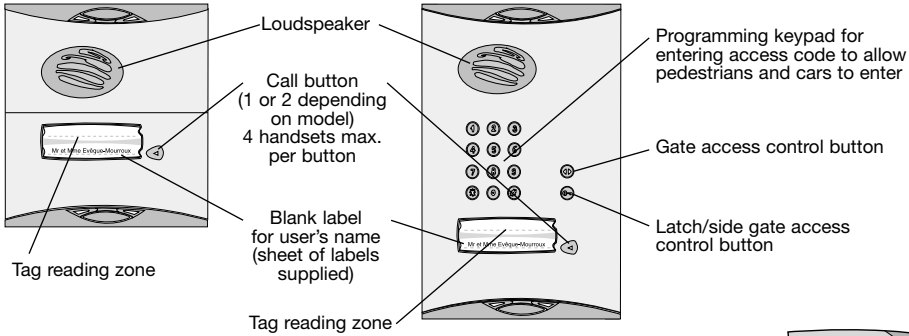

Tag (1 or 2 tags per kit depending on the model)

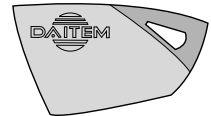

2.1.2 Controller

• Mains-powered controller or Lithium battery controller

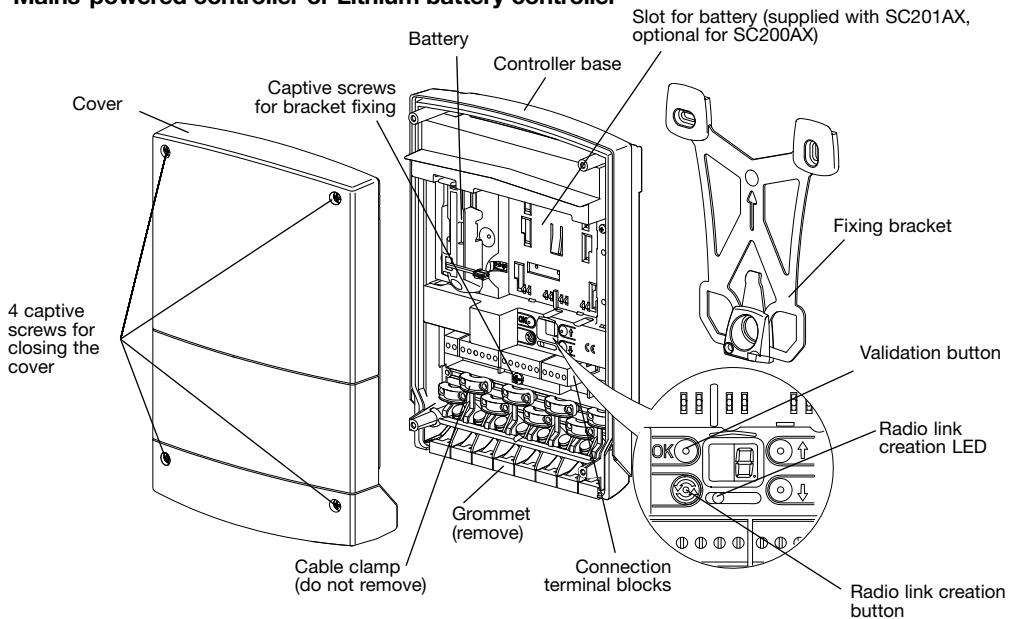

IMPORTANT: the grommets, cable clamps and screws for the cable clamps are in the bag of accessories.

• **Alkaline batteries controller**

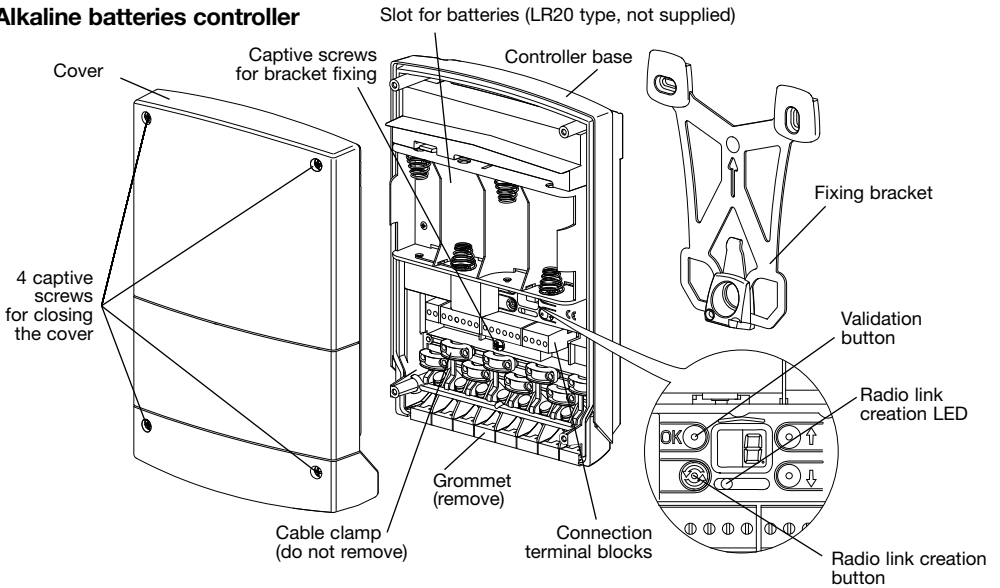

IMPORTANT: the grommets, cable clamps and screws for the cable clamps are in the bag of accessories.

2.2 Interior handset unit

2.2.1 Base

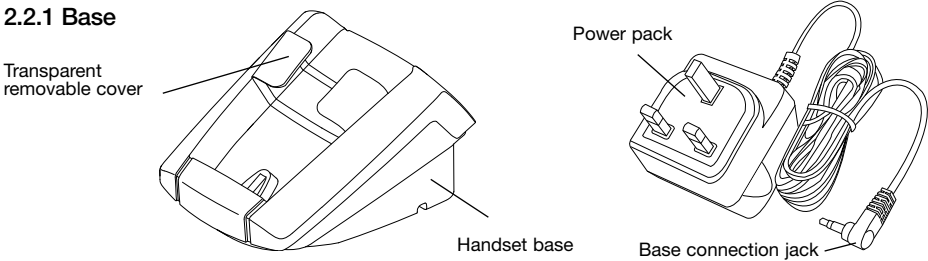

2.2.2 Handset unit

IMPORTANT: when installing the system, the handset(s) must be charged on their base before they can be used.

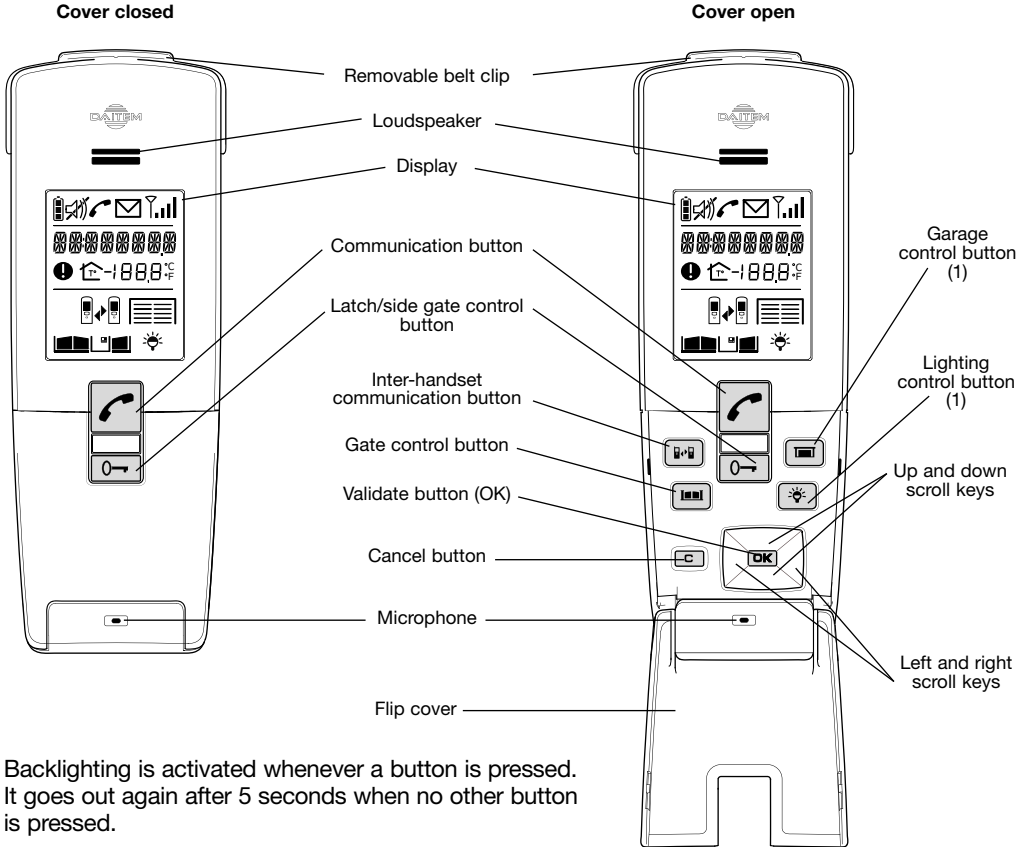

Backlighting is activated whenever a button is pressed. It goes out again after 5 seconds when no other button is pressed.

(1) These functions require a relay output receiver to be installed.

Belt clip

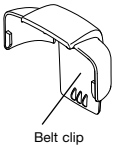

If necessary, fit the belt clip to the handset as shown:

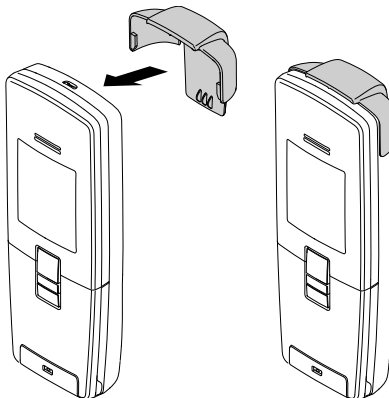

2.2.4 Display description

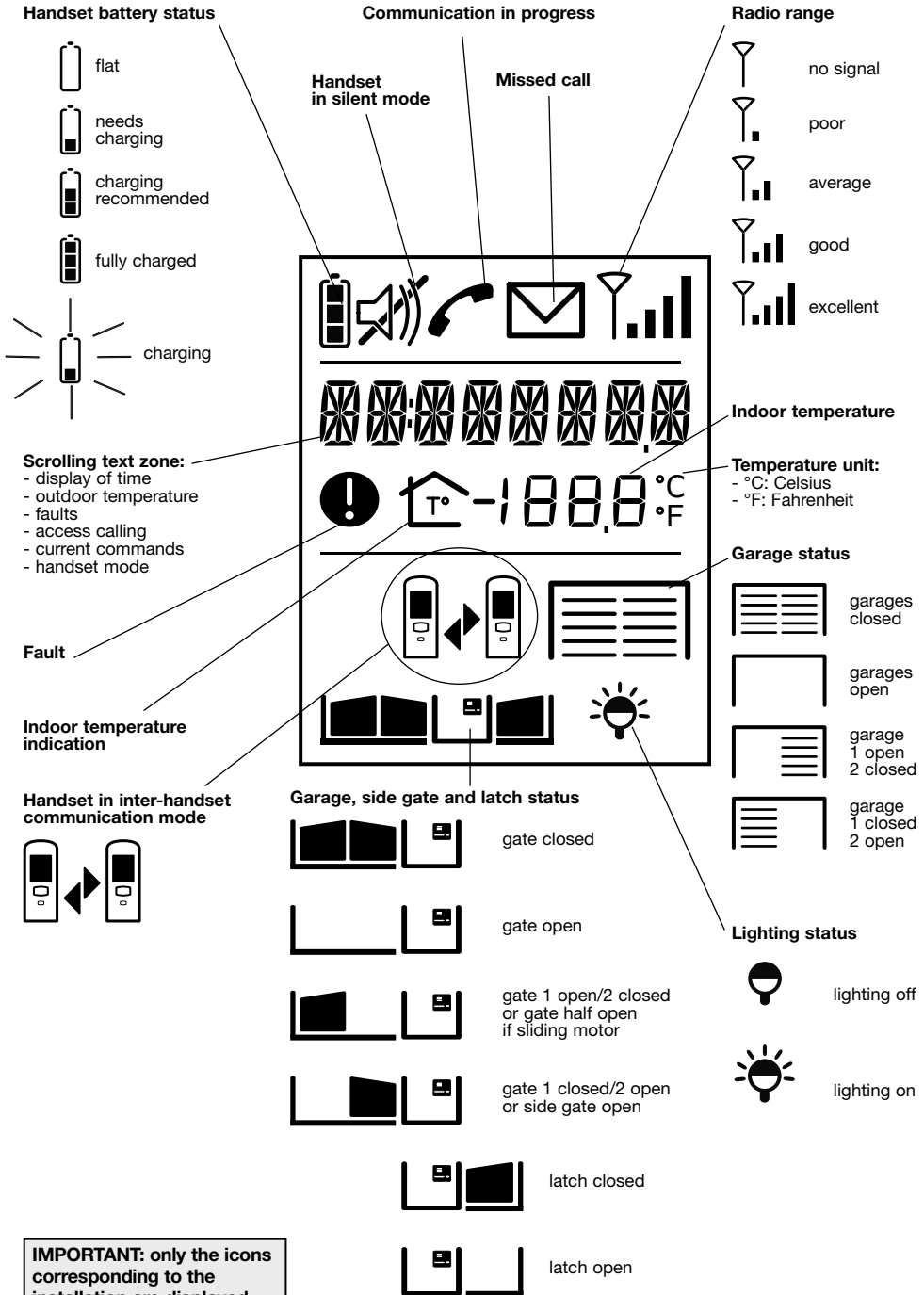

2.2.5 Handset display in standby mode (general information screen)

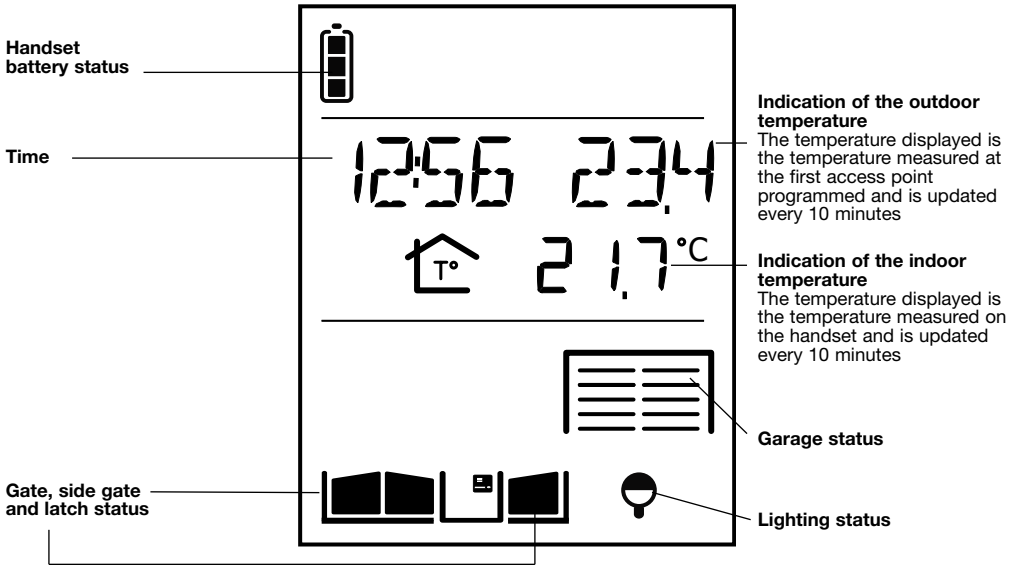

3. Tooling required

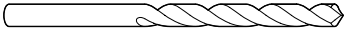

∅ 6/8 mm

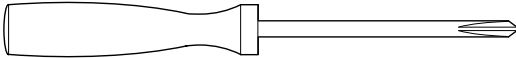

⊕ PZ 0 / PZ 2
3 mm / 6 mm

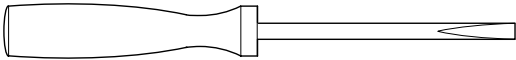

⊖ 3.5 mm

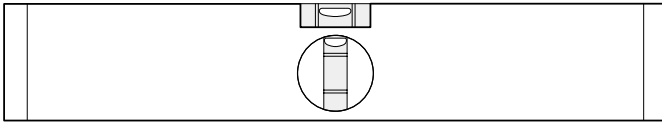
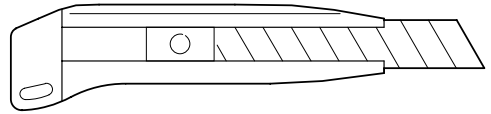
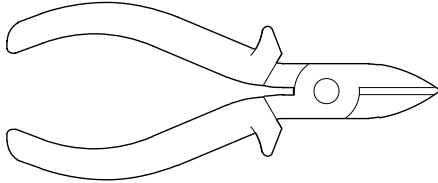

GUARANTEE

The conditions according to which the guarantee and after sales service apply are described in the general price list and can be sent on request.

Some after sales service products and accessories, such as:

- MHU01U power pack
- SC501AX interior handset unit base
- SC501AX belt clip
- SC801AX handset flip cover

(non-exhaustive list for indication purposes only) have a 2-year manufacturer guarantee, which cannot be extended.

4. Preparation

4.1 Guarantee stickers

Remove the **pre-cut parts** of the stickers and stick these to the extension request supplied.

On the back of the caller unit

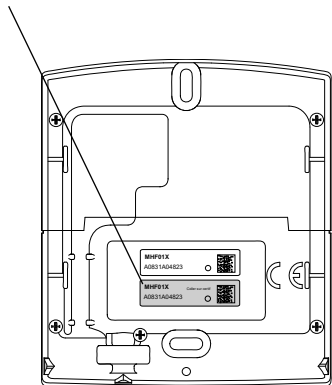

On the handset

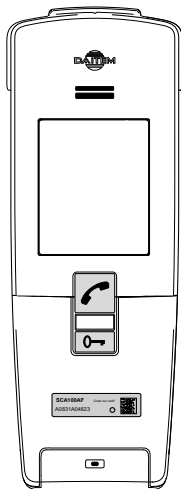

Inside the controller

1. Unscrew the 4 cover screws and open the controller.

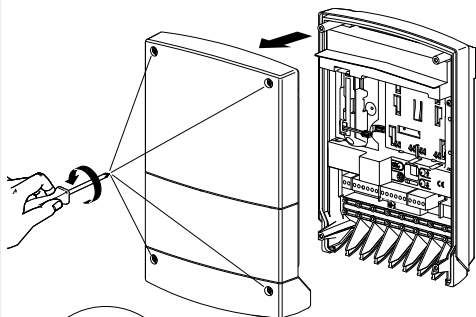

2. Remove the **pre-cut part**.

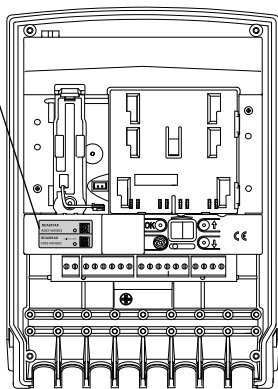

Pozidriv 2

4.2 Charging the handset before installation

IMPORTANT: when installing the system, the handset(s) must be charged on the base before it/they can be used.

4.2.1 Handset on mains-powered base

1. Open the base.

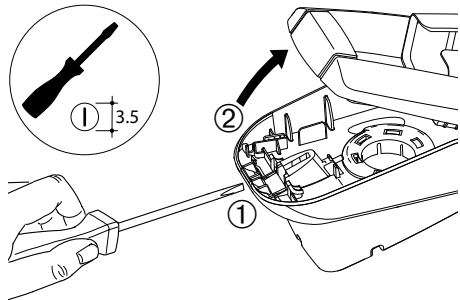

2. Remove the 4 anti-slip pads.

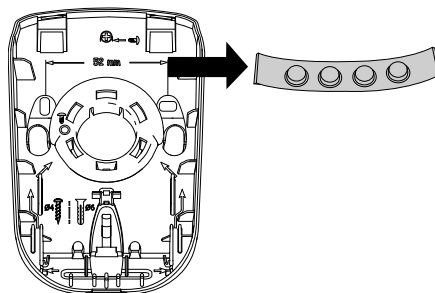

3. Rotate the back of the base until it is in “table” position.

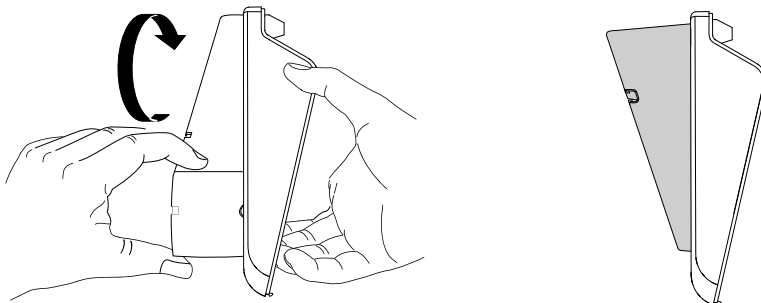

4. Thread the power pack jack through the hole.

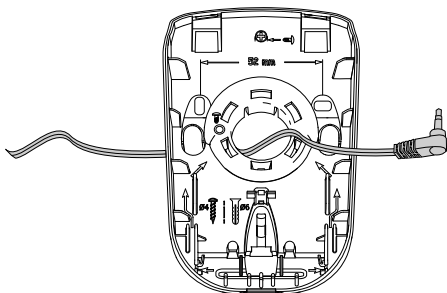

IMPORTANT: the MHU01U power pack supplied must be used.

5. Connect the jack to the base making sure that the cable is positioned in the designated slot.

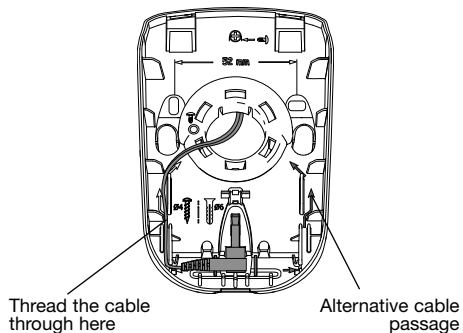

6. Thread the power cable into one of the guides at the back of the base.

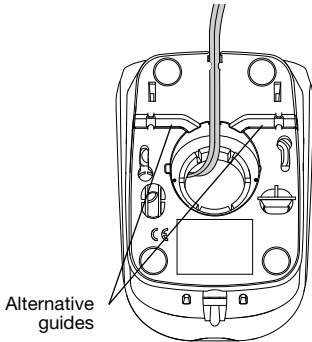

7. Unscrew the locking screw.

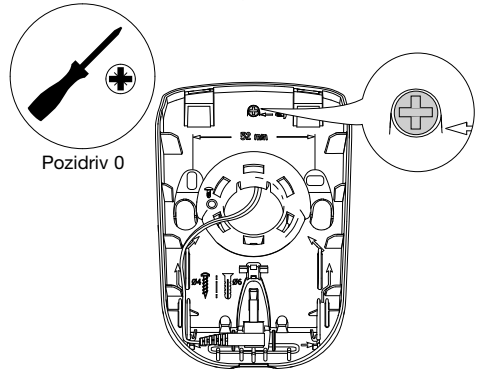

8. Screw it back into the same place hence locking the base in "table" position.

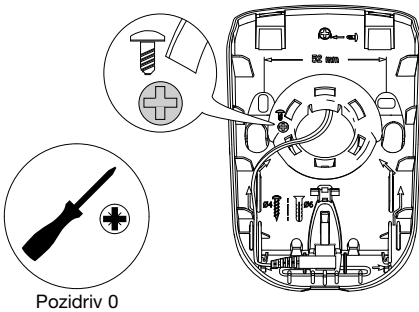

9. Close the base.

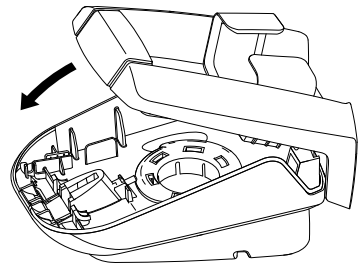

10. Tighten the locking screw to prevent the base from being opened by mistake.

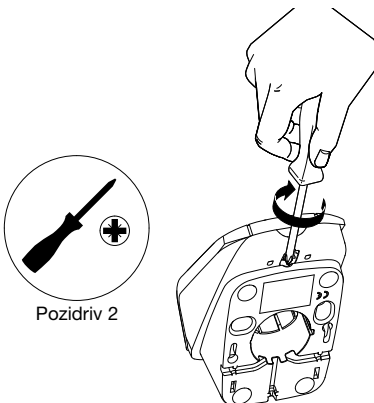

11. Stick the 4 anti-slip pads to the back of the base and then put it on the table.

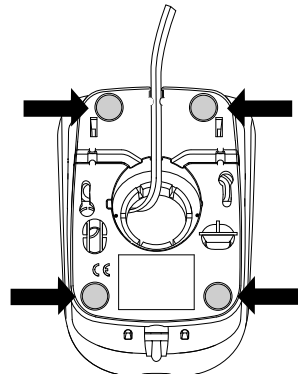

12. Connect the power pack to the mains (220 V).

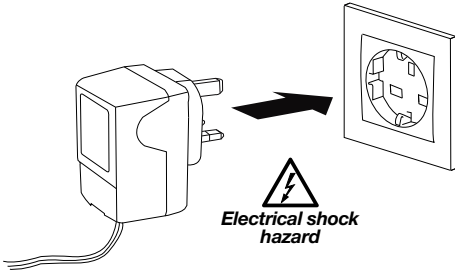

IMPORTANT: the mains socket must remain accessible so that the power pack can be easily disconnected.

13. Put the handset on the base.

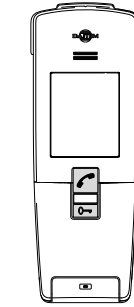

The handset displays this message for 2 sec.

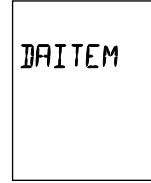

Then CHARGING if the battery is not sufficiently charged (1).

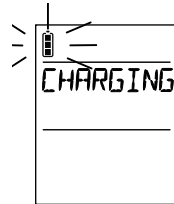
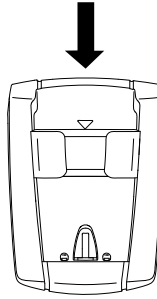

or

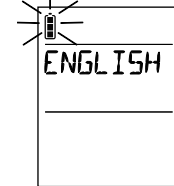

If the battery is sufficiently charged.

You can now move on to the next chapter describing how to install the doorphone.

TIP: to make it easier to pick the handset up, the removable transparent cover can be removed.

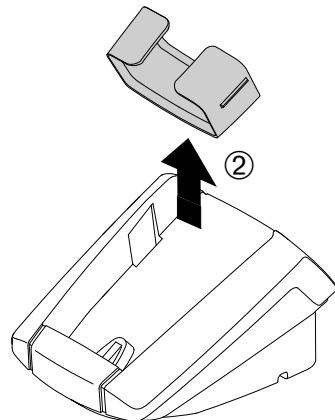
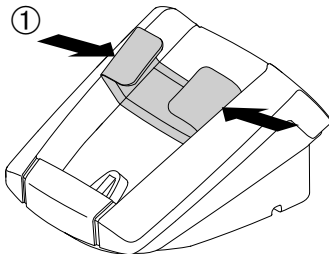

(1) For the rechargeable handset battery life to last its full period (15 days) when off its base, it must be left on its base to charge for at least 2 days beforehand (during which time it can of course be used).

5. Installing the outdoor system

5.1 Installing the outdoor caller unit

IMPORTANT: to ensure the outdoor caller unit remains watertight, never try to open it!

1. To ensure easy use, fix the unit at a height of 1.20 m.

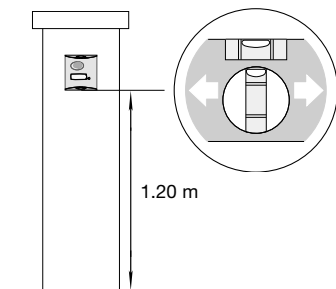

2. Mark and drill the outdoor caller unit holes with a \varnothing 6 mm drill bit. Also mark the place where the cable feed hole has to be drilled (\varnothing 8 mm min. recommended).



Please refer to the next chapter for mounting outdoor caller units with armoured cover. Follow steps 3 to 6 below for units without armoured cover.

3. If the cable goes around the pillar, pierce one of the cable knock-outs with a cutter.

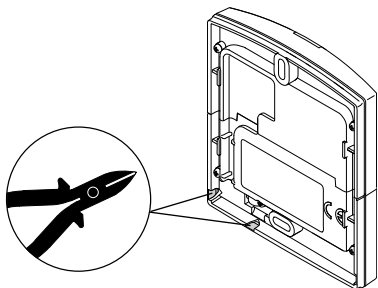

4. Push the screw covers out using a flat screwdriver.

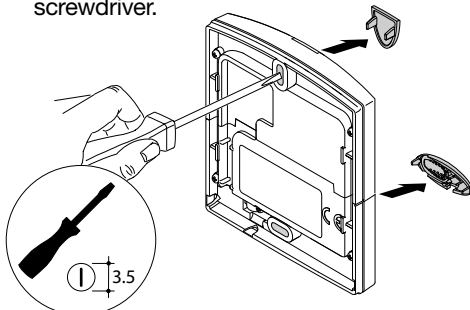

5. Thread the cable through the hole knocked out in step 3 and screw the caller unit in place. Put the screw covers back.



Pozidriv 2

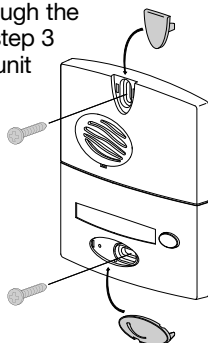

6. Use a pencil or permanent marker to write the names. Stick a transparent protection label on top.

TIP: you can print the labels using the software (EtikPrint) available on the Daitem web site.

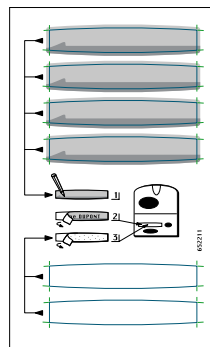

Mounting the outdoor caller units with armoured cover

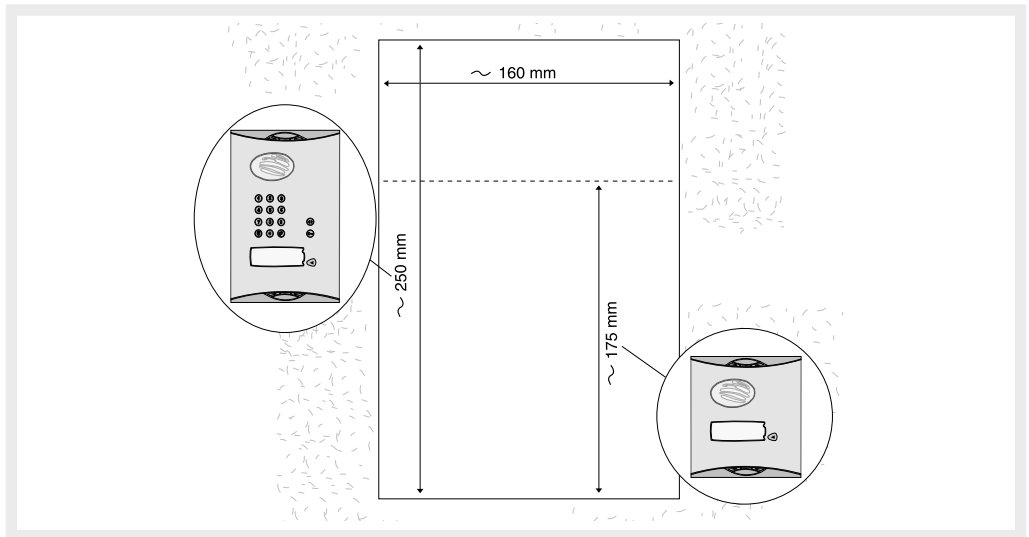
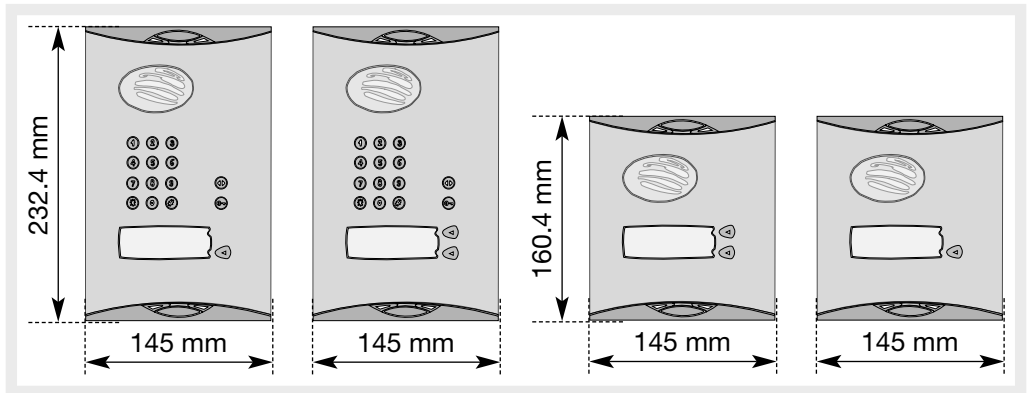

TIP: you can print the labels using the software (EtikPrint) available on the Daitem web site.

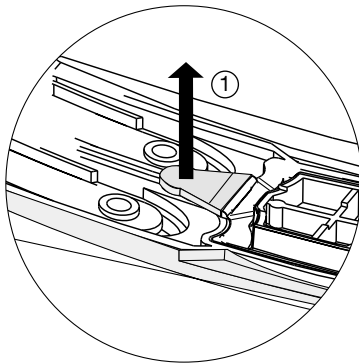

IMPORTANT: use the label supplied and carefully position it in the space provided.

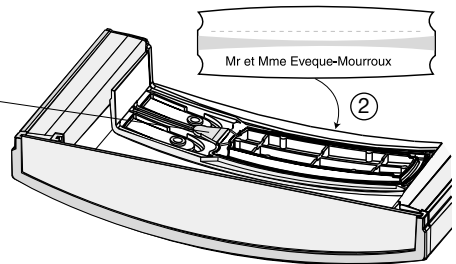

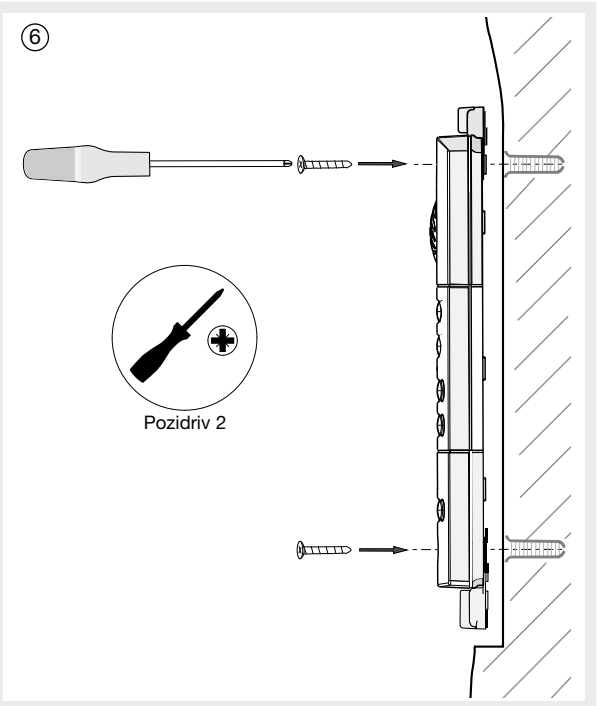
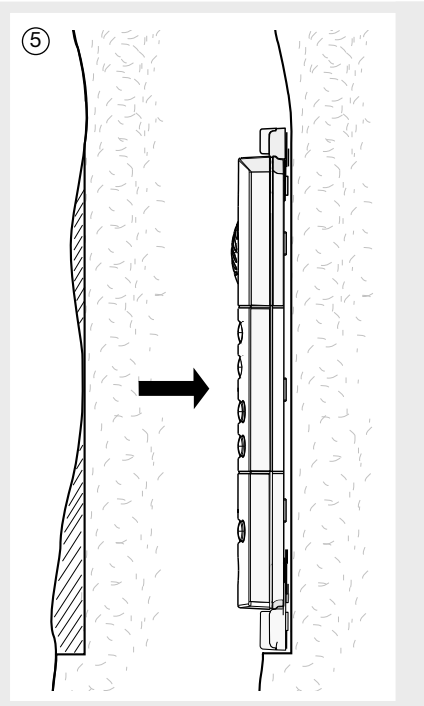
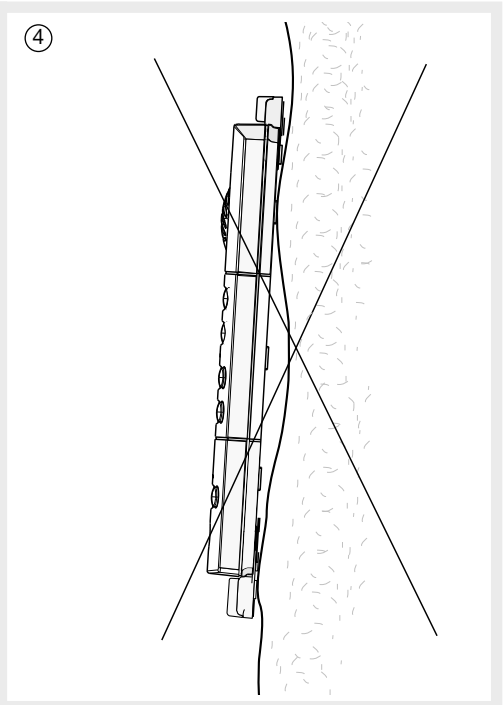
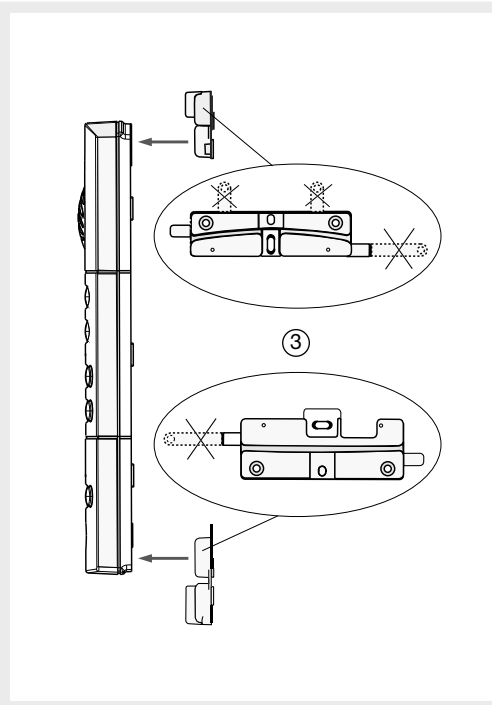

7

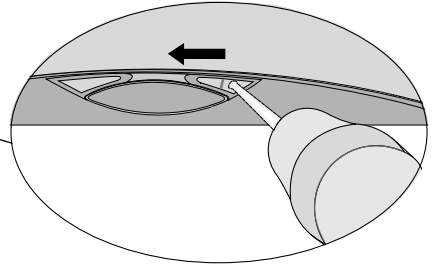
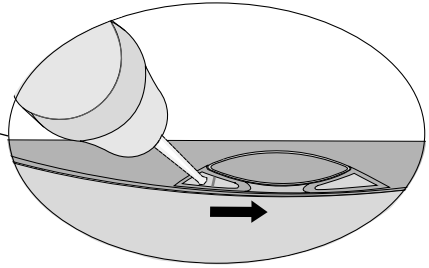
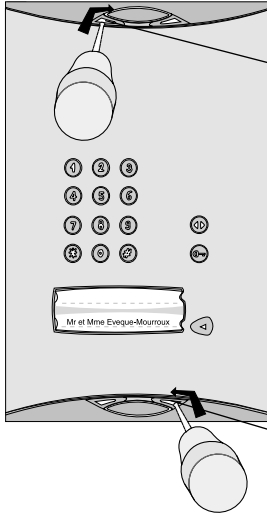
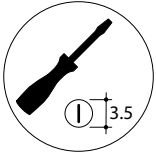

8

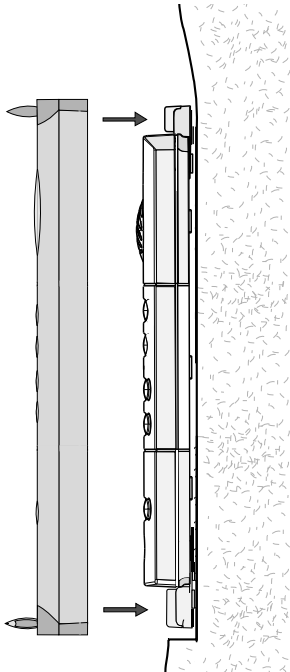

9

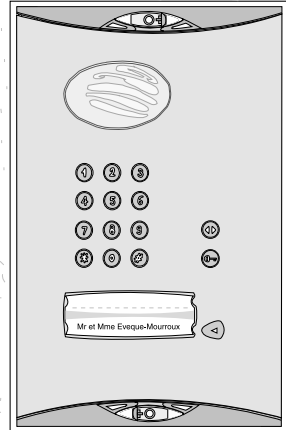

10

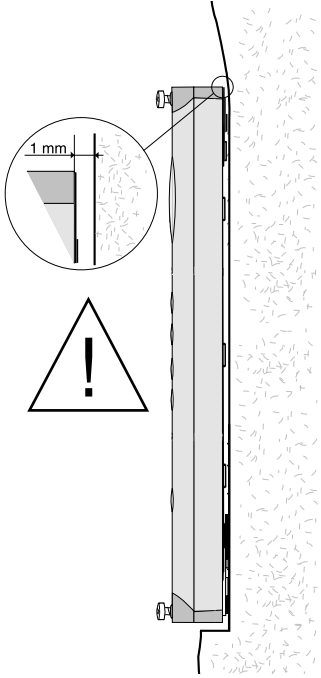

11

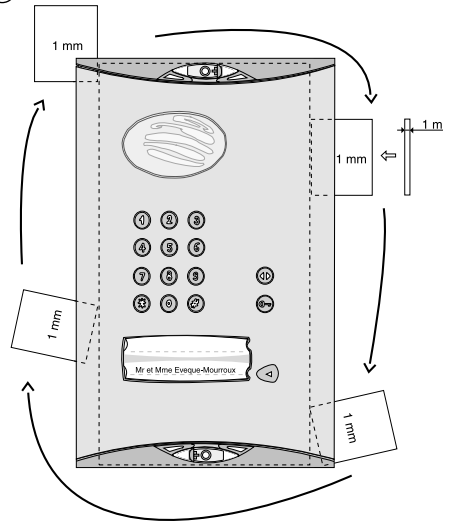

IMPORTANT: when the armoured cover is positioned on the unit, there should be a 1 mm clearance (use the shim for this purpose) between the pillar and armoured cover.

12

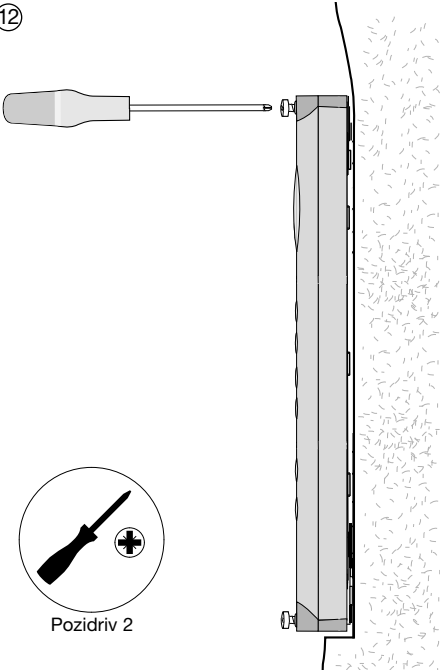

5.2 Installing the controller

1. Unscrew the locking screw from the bracket and then remove it.

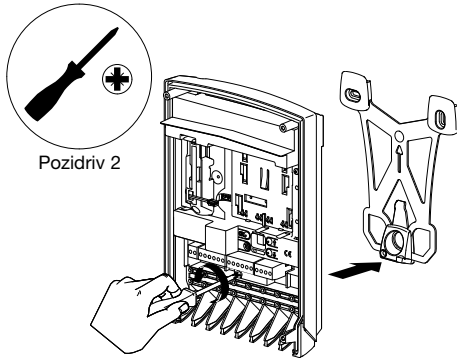

2. Following the installation rules below, mark 3 fixing points and drill a hole in the pillar using a $\varnothing 6$ mm drill bit.

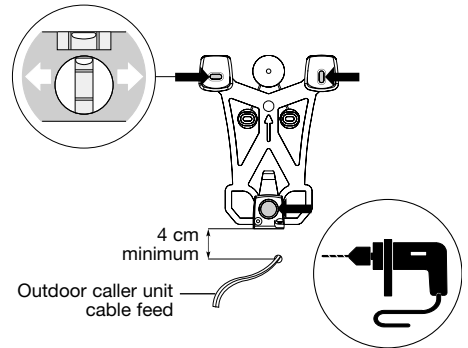

Installation rules

To make it easier to hook the base on to the bracket choose a flat surface (or make the surface as flat as possible) on the garden side of the pillar. This is especially important for the top part of the bracket.

To guarantee an excellent radio range:

- keep the space clear around the controller,
- remove any dense vegetation nearby and make sure the area is always clear,
- place the controller as high up as possible (80 cm min.),
- make sure there are no obstacles between the controller installation point and the house where the handset(s) is/are installed.

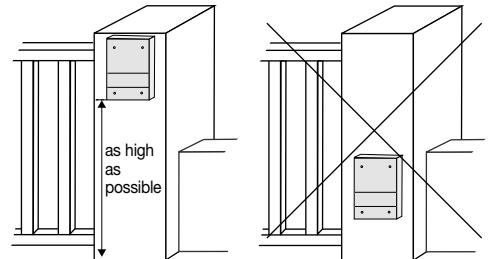

Do not wind the cable up nearby or inside the controller. Instead, cut off any excess length.

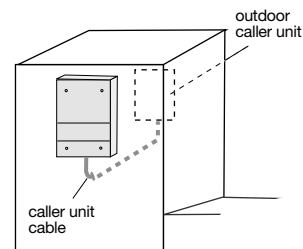

Do not place the products near metal surfaces (screens, fences, gates, etc.) or sources of electromagnetic disturbance:

- for the controller: electricity meter, high voltage line, lighting control system, radio receiver, etc.
- for the handset: hi-fi equipment, video, household appliance, electricity meter or switchboard, lighting control system, etc.
- the controller must be more than 3 m away from the interior handset unit.

3. Insert a washer and fix the bottom and then the top of the bracket.

Fixing without a washer

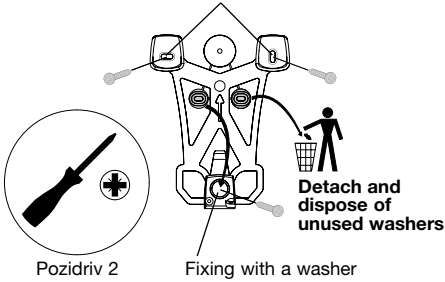

4. Hook the base on to the fixing bracket.

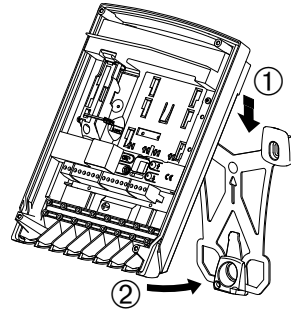

5. Lock the base in place using the locking screw.

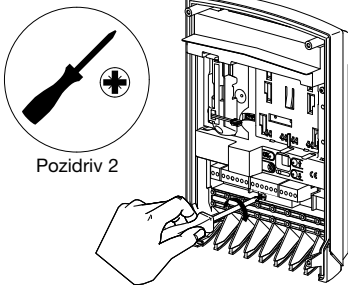

5.3 Connecting the equipment

1. To make it possible to thread the cables through (for the outdoor caller unit, external power supply, motorisation system, etc.), remove the grommets and pierce a hole with the same diameter as the cable using a Philips screwdriver.

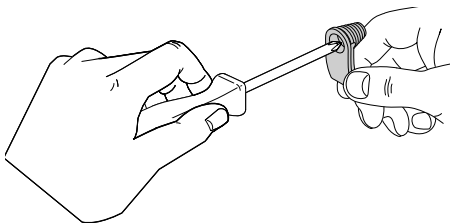

2. Cut the cables to the necessary length and then thread them through the grommets. Expose the end of the wires over a length of approximately 1 cm.

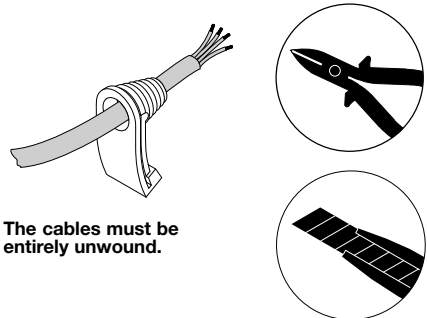

TIP

- All terminal blocks can be unplugged to facilitate wiring.
- The connections to be made are summarised on a label inside the controller cover.

3. Connecting the outdoor caller unit

Connect the 4 outdoor caller unit wires to terminal blocks 15 to 18 on the controller.

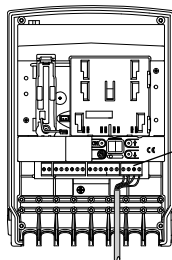
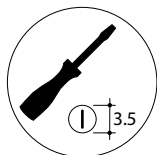

15/Green: Data -
16/Yellow: Data +
17/Red: power +
18/Black: power -

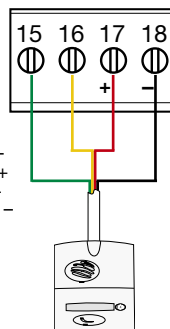

TIP: if the cable between the outdoor caller unit and the controller has to be extended, keep or shorten the length of the cable supplied and then connect the wires to a branch box in accordance with the rules below:

- up to 10 m (including the remaining length of the original cable): use 4 x 0.32 mm² cross-section cable (AWG22) for the 4 wires
- from 10 to 15 m (including the remaining length of the original cable):
 - use 2 x 0.75 mm² cross-section cable (AWG18) for the supply wires (red and black),
 - use standard 2 x 0.16 mm² bunched cable (AWG25) with an impedance Z of 124 Ω for the Data wires (green and yellow)
- from 15 to 25 m (including the remaining length of the original cable):
 - use 2 x 1.5 mm² cross-section cable (AWG15) for the supply wires (red and black),
 - use standard 2 x 0.16 mm² bunched cable (AWG25) with an impedance Z of 124 Ω for the Data wires (green and yellow).

4. Connecting an electrical latch

Connect the latch according to the following cable cross-sections:

- in 3 and 4: 0.75 mm² up to 15 m/1.5 mm² up to 30 m,
- in 5, 6, 7 and 8: 0.22 mm² (telephone type wire).

IMPORTANT: so that the system recognises the latch, it must be wired before the radio link is created between the handset and the controller.

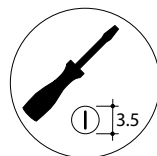
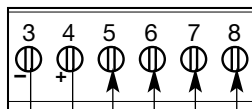

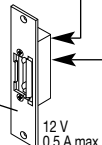

Electrical latch or lock control (no need for external power supply)



Push-button located on the garden side for manual latch control. Place this control device out of reach and sight in relation to the road (connection not compulsory).

The position contact feeds back the latch status to the screen:

IMPORTANT: for the information feedback to be properly managed, the position contact (ref. CP500 on the price list) must be wired before power-up and be in closed position when the radio link is established between the handset and the controller. If no contact is connected, the handset display will show the latch is closed whatever its status.

-  latch closed (contact closed),
-  latch open (contact open).

5. Connecting a gate motorisation system

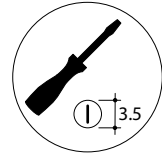
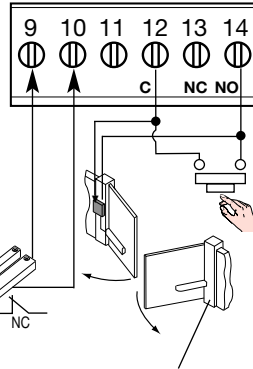

Use a cable cross-section of 22 mm² (telephone type wire) to connect the system.

IMPORTANT: for the information feedback to be properly managed, the position contact (ref. CP500 on the price list) must be wired before power-up and be in closed position when the radio link is established between the handset and the controller. If no contact is connected, the handset display will show the gate is closed whatever its status.



If a push-button allowing manual control of the automatic system has already been installed, connect terminal blocks 12 and 14 in parallel on this manual control input.

The position contact feeds back the gate status to the screen:

-  gate closed (contact closed),
-  gate open (contact open).

Gate motorisation control, 48 V DC/1 A dry contact relay output. The motorisation system requires an external power supply.

5.4 Controller power supply

1.A Mains-powered controller or Lithium battery controller

Three types of power supply can be used.

• Lithium battery

IMPORTANT: 908-21X battery must be installed for current-based applications. Connect the battery supplied to the connector.

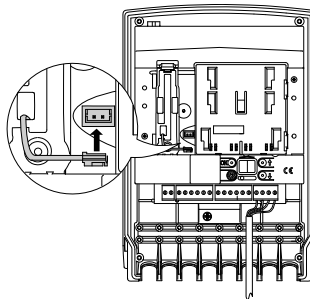

then connect the battery by positioning it on the rails and sliding it downwards.

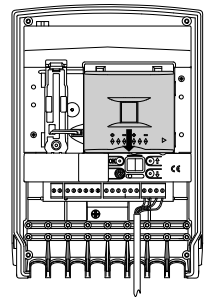

• **Transformer**

Connect a 12/24 V AC or 12/30 V DC power pack to terminal blocks 1 and 2 of the controller (transformer A7901 available in the catalogue). There are no polarities to be respected on these terminals.

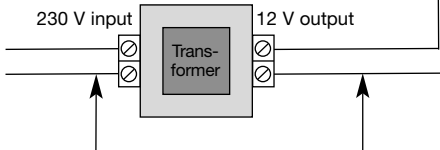
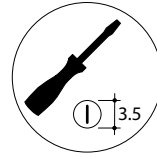
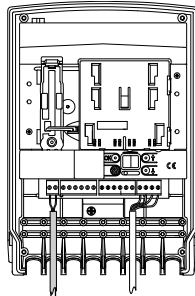

IMPORTANT: the transformer used must have the 12 V/10 VA min. double insulation symbol (230 V power supply without an earth connection).

Cable length and cross-section	0 to 10 m → 0.32 mm ²
	10 to 25 m → 0.75 mm ²

Optional

Connect the 908-21X battery supplied to its connector. It will be used in the event of a power cut.

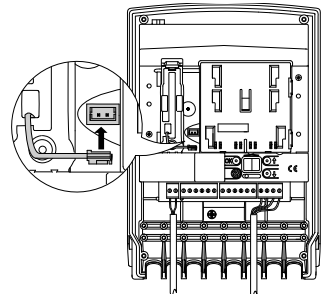

• **Solar panel**

Connect a 12 V/8 W min. power solar panel (ref. MJU01X on price list) to terminal blocks 1 and 2 on the controller. There are no polarities to be respected on these terminals.

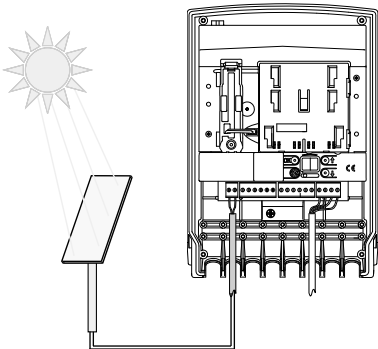

IMPORTANT: 908-21X battery must be installed for current-based applications. Connect the battery supplied to the connector.

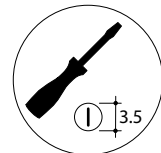
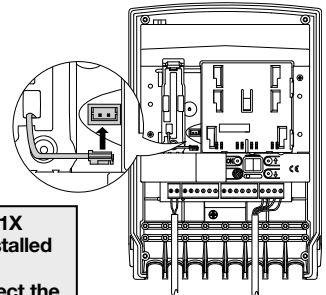

1.B Alkaline batteries controller

1. Two types of power supply can be used.

• Alkaline batteries

Position the 4 LR20 1.5 V batteries (not supplied) making sure they are the right way round.

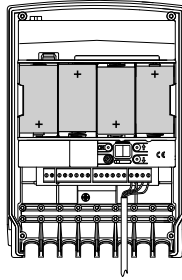

IMPORTANT: push the batteries into their slot making sure that the + pole of each one is in contact with the metal part.

• Transformer

Connect a 12/24 V AC or 12/30 V DC power pack to terminal blocks 1 and 2 of the controller (transformer A7901 available in the catalogue). There are no polarities to be respected on these terminals.

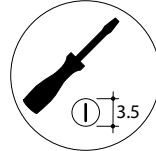
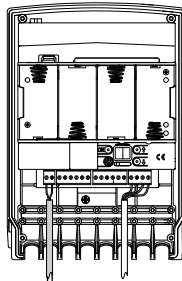

IMPORTANT: the transformer used must have the 12 V/10 VA min. double insulation symbol  (230 V power supply without an earth connection).

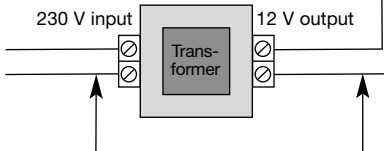

Cable length and cross-section	0 to 10 m → 0.32 mm ²
	10 to 25 m → 0.75 mm ²

Optional

Position the 4 LR20 1.5 V batteries (not supplied) making sure they are the right way round. The batteries are used as back-up in the event of a mains power failure.

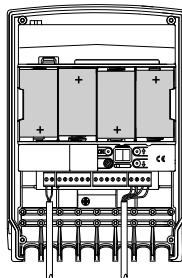

2. When powered, the outdoor caller unit lights up and beeps every 2 sec. The radio link creation LED also lights up red for 2 sec.

If this is not the case, check that the controller's batteries or external power supply are properly connected.

If the radio link creation LED flashes three times every 5 seconds:

- remove the controller's power supply,
- check the outdoor caller unit wiring,
- reconnect the controller's power supply,

or

- the battery is not connected.

Check it is inserted and/or connected.

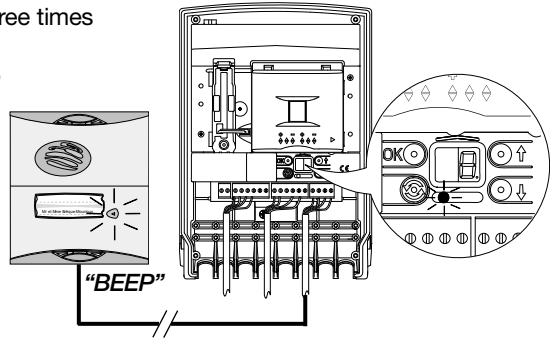

3. To ensure the controller is watertight, all the grommets must be positioned and locked into place the right way round.

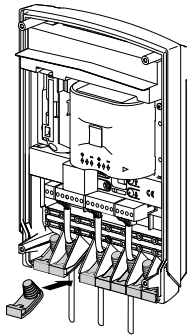

4. Use the cable clamp and screws provided to lock the cables in place.



Pozidriv 2

Do not loosen the cable clamps.

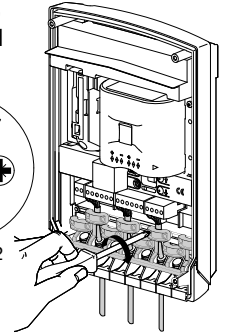

5.5 Creating the radio link between the handset and the controller

IMPORTANT: each call button on the outdoor caller unit can be linked via radio with up to 4 handsets.

1. At this stage in the installation procedure, the handset should display:

If this is not the case, the handset needs to be charged (see chapter on Charging the handset before installation) until the language selection message is displayed.

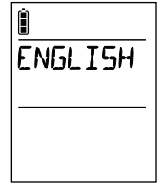

2. Pick up the handset, open the cover and select the desired language (1) using the following keys



then **OK**.

The handset beeps for 2 sec .

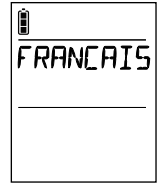

3. Programme the time (1):

A/ set the first digit using the keys

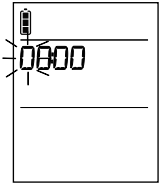

B/ set the next digit using the key



The  key selects the previous character

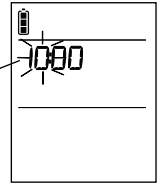

C/ return to steps **A** and **B** to set the minutes and then, once the desired time has been programmed, press **OK**.

The handset beeps for 2 sec .

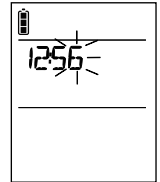

4. The handset then moves on to radio link set-up mode and displays:

IMPORTANT: after 2 minutes, the handset exits radio link creation mode and displays:

Reprogramme the time (Step 3 in this chapter), then refer to the procedure described in chapter "9.1.5 Specific cases, creating a radio link between a handset and several controllers or several outdoor caller unit call buttons" in order to create the radio link between the controller and the handset.

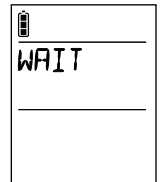
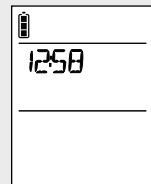

5. Pick up the handset, stand next to the controller and follow the procedure on the next page:

(1) These parameters can be modified at a later stage (see User manual/Modifying handset operating options/Modifying options for use).

Controller

6. Put the controller in radio link creation mode by pressing 

The radio link creation LED lights up orange.

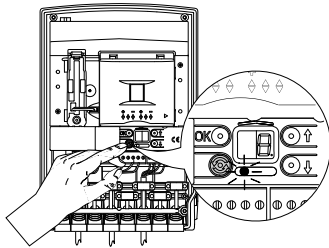

7. The radio link creation LED lights up orange.

Handset unit

The handset displays:

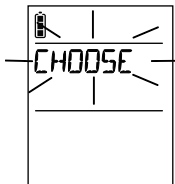

Outdoor caller unit

8. Press once on the outdoor caller unit call button so that it calls the handset.

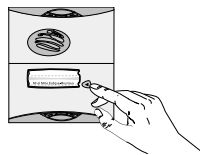

IMPORTANT: when using a translucent MHF01X or MHF02X outdoor caller unit and 1-button armoured cover, only the bottom key (KEY 1) can be accessed once the armoured cover has been placed on the unit.

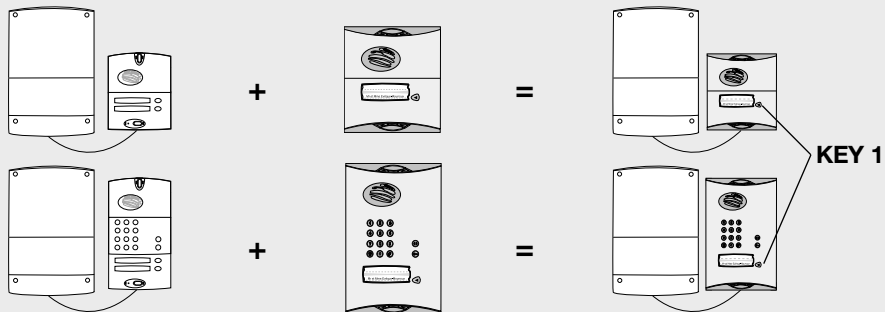

Controller

Handset unit

Outdoor caller unit

The radio link LED lights up green for 2 sec.

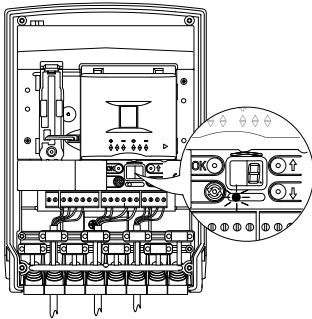

9. The handset displays:

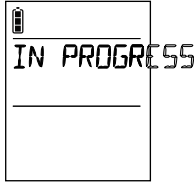

then

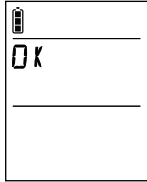

beeps for 2 sec and

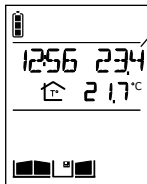

Display of time, indoor and outdoor temperature, gate, side gate and latch status (if position contacts connected).

The outdoor caller unit beeps for 2 sec.



The radio link has been created.

If an error occurs, the handset displays:

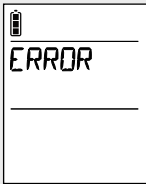

It beeps 3 times and then automatically returns to the next screen:

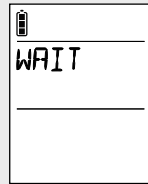

Start the radio link creation procedure again.

Carry out the radio link creation procedure again for all the handsets.

Close the controller.



Pozidriv 2

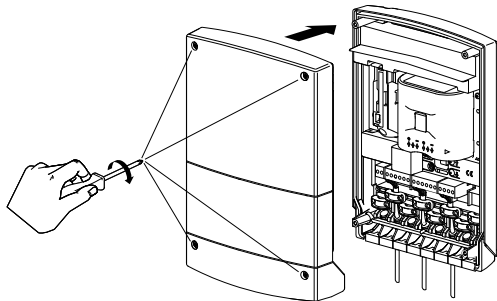

6. Testing the radio range

Before installing the handset base, make sure the radio range between the handset and the controller(s) is good.

1. Stand in the place you wish to install the handset unit and quickly press the  key.
2. If you have several access points: select the access point from where you would like to listen in to background sounds using the keys



then .

3. You can hear what is happening around the outdoor caller unit at the selected access point. Reception is good if at least 3 bars are displayed.

If this is not the case, move the handset.



Radio range bar graph

4. Press on the  key and test the radio range again for each access point.

IMPORTANT: if the handset units or controllers are too close to each other when you are testing the radio link, this may generate interference (Larsen effects, crackling, etc.). Move the various devices over 3 metres away from each other.

7. Installing the interior handset unit

7.1 On a table

The table mounting procedure is described in the chapter on Charging the handset unit before installation.

7.2 On a wall

This chapter describes how to move the handset unit from a “table” position (in which the handset unit is normally placed at this stage in the installation, see chapter on Charging the handset unit before installation) to a “wall” position.

7.2.1 Handset on mains-powered base

1. Remove the handset from the base.

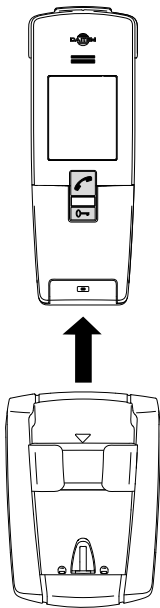

2. **IMPORTANT:** the removable transparent cover must be in place when fixing the unit to the wall. If this is not the case, clip it back on.

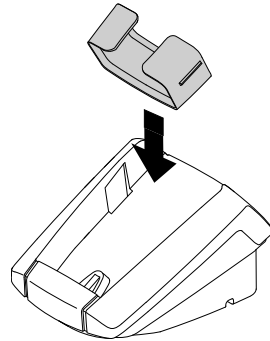

3. Disconnect the power pack.

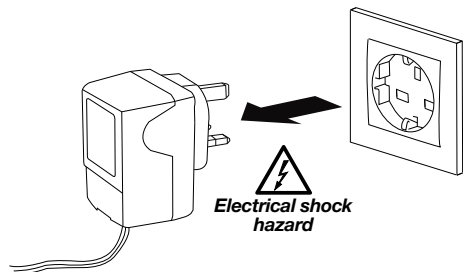

4. Unscrew the base locking screw.

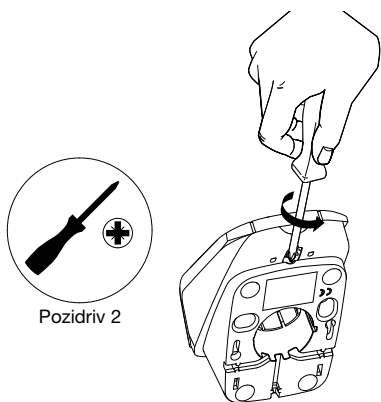

5. Open the base.

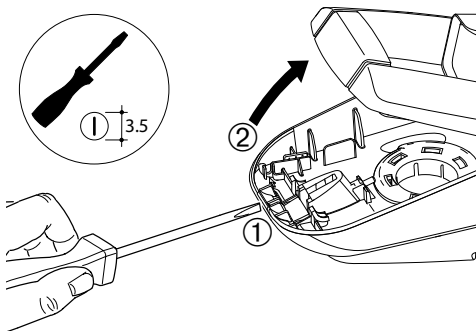

6. Unscrew the locking screw.

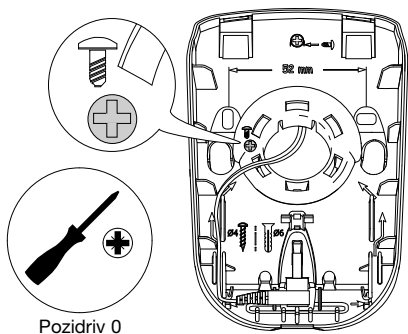

7. Insert the screw here and tighten it.

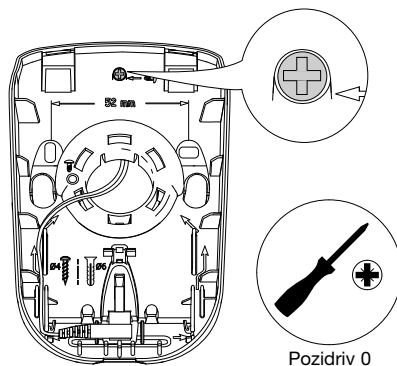

8. Rotate the back of the base until it is in wall position.

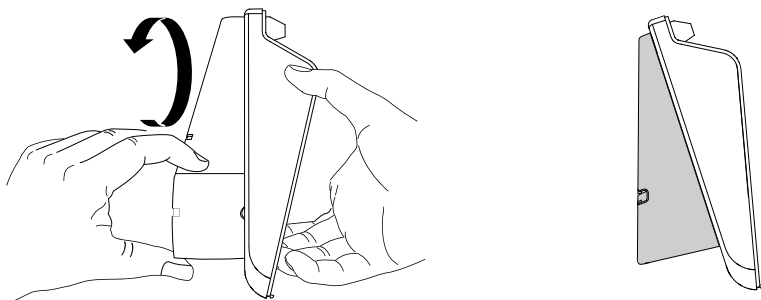

9. Mark the 2 fixing points and then make a hole using a \varnothing 6 mm drill bit.

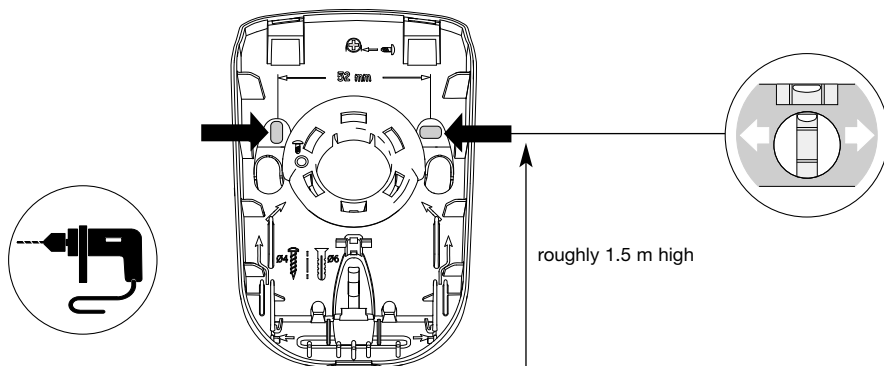

10. Check the power pack jack is in the right position.

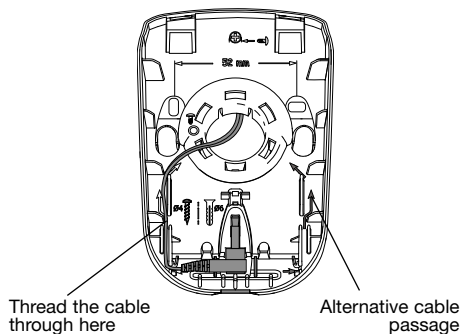

11. Feed the power cable through one of the guides on the back of the base.

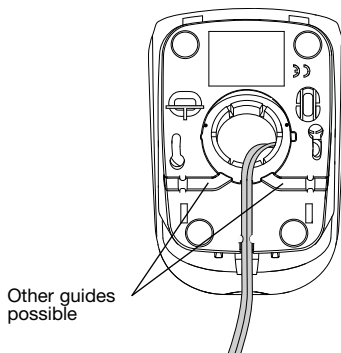

12. Fix the base to the wall using appropriate washers and screws.

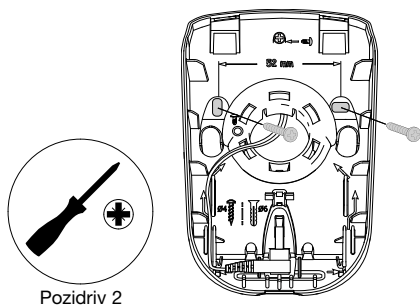

13. Close the base.

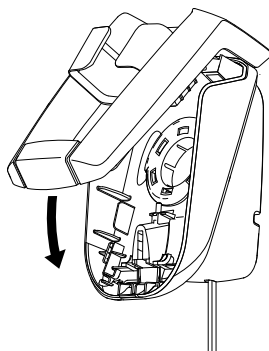

14. Tighten the locking screw.



Pozidriv 2

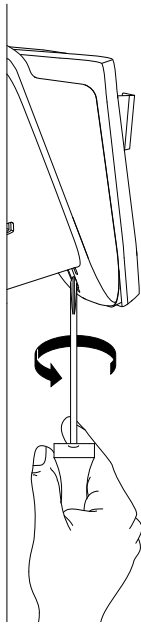

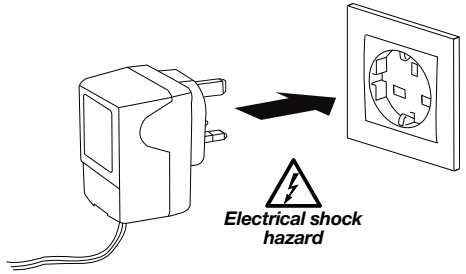

15. Connect the power pack to the mains (220 V).

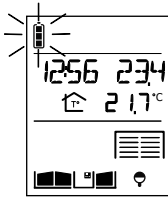
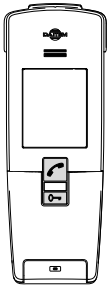

IMPORTANT: the mains socket must remain accessible so that the power pack can be easily disconnected.

16. Place the handset on the base.
The handset beeps once.



If necessary, the  icon flashes to show the handset is being charged.

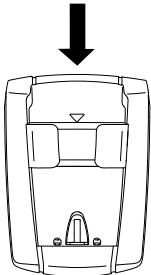

8. Testing operation

8.1 Testing communication with each interior handset unit

1. Press on the outdoor caller unit call button.

To confirm the call, the outdoor caller unit rings at regular intervals for 30 sec.

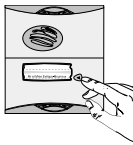

IMPORTANT

If the handset being called is already:

- communicating with another outdoor caller unit or handset,
- outside the radio range, the outdoor caller unit sounds engaged.

2. The handset rings (1) (except if it is in silent mode), and the backlighting flashes.



The name of the access point calling (2) is displayed.

3. If the handset is on its base, pick it up:
 - if the automatic pick-up mode is activated, communication is established,
 - otherwise, press the  key.

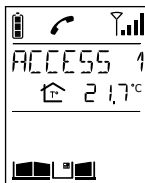

If the handset is already off the base, press .

4. Open the flip cover to talk and adjust the audio communication volume using the keys.

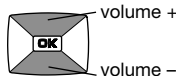

5. At the end of communication, press .

and/or put the handset back on the base to hang up (the handset issues 3 beeps if it is correctly placed on the base).

If no button is pressed, the communication is automatically cut off after 3 minutes.

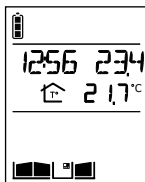





Perform the same test for all of the handsets

- (1) If there is no answer, the handset rings for 20 sec. (factory setting) then stops. The duration of ringing can be adjusted (see Programming handset operating options). If the handset is on the base, it rings at the programmed volume (see Modifying handset operating options). If the handset is off the base, ringing gradually becomes louder (from level 1 to the programmed volume).
- (2) Access point names can be customised (see Modifying doorphone operating options).

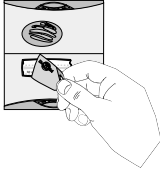
8.2 Testing access controls

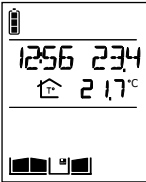
IMPORTANT: to test the access controls, it is first necessary to register a tag or programme an access code on the outdoor caller unit (see User guide/11.2 Modifying tag options/11.3 Modifying access code options).

Activate the outdoor caller unit	Status display on the handset (1)	Latch access status
<p>1. Hold the tag in front of the name label.</p>  <p>Or enter the access code (2)</p> 		<p>Closed</p>
<p>2. If a latch is connected, it will be unlocked within 5 seconds.</p> <p>or</p> <p>If a gate alone is connected (without a latch), side gate access is unlocked within 5 seconds.</p>	 <p>or</p> 	<p>Open</p>

For additional tests (gate access, listen-in and inter-handset communication functions, etc.), please refer to the corresponding chapters in the user manual.

The doorphone is now operational. If need be, you can customise it by following the instructions in the chapters on Modifying outdoor caller unit operating options and Modifying handset operating options in the user manual.

(1) If a position contact is connected.

(2) If you press the wrong button, press  then enter the access code again.

9. Appendices

9.1 General information about creating the radio link

An OPTWIN installation is a home-control system in which all the doorphone products communicate with each other via a hardwired bus or radio.

It comprises different types of products that can be classed according to their function at a given time T in the installation:

- “Transmitter” products: these send commands or information following actions (e.g. when the handset Light button is pressed) or events (e.g. when the gate is closed via the controller). A “Transmitter” product can generate several different commands (e.g. Light or Garage buttons on the handset).
- “Receiver” products: these receive commands and information and activate the appropriate applications (lighting, automatic control system, etc.) or respond according to their programming. These applications or responses are also called functions. A “Receiver” product can have several functions (e.g. 2-channel relay output receiver, strobe and siren sounding, etc.).

It should be noted that products may act as “Transmitters” and “Receivers”.

Examples:

Audio communication between the handset and the outdoor caller unit. The handset is considered as the receiver while the controller/outdoor caller unit act as the transmitter.

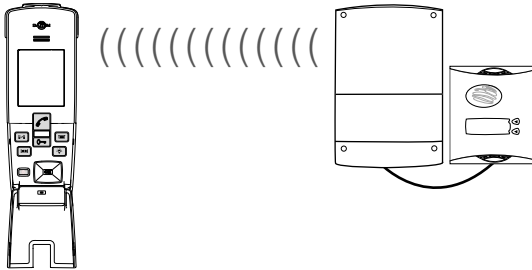

The Light button on the handset controls the lighting connected to the relay output receiver. The handset is considered as the transmitter while the output receiver acts as the receiver.

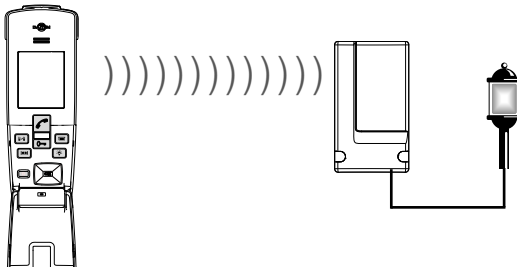

Configuring an OPTWIN installation consists in:

- Creating radio links between the different transmitter and receiver products to define who controls who and who sends information to whom.
- Allocating a function to each radio link, e.g. when the Light button on the handset is pressed, this activates the lighting controlled by the output receiver for 5 minutes.

A radio link is created and a function is allocated to this radio link as part of the same procedure. This procedure is as follows:

Transmitter

1. Switch to radio link creation mode.

4. Select the button or event associated with the function.

5. Validate the procedure.

Receiver

2. Switch to radio link creation mode.

3. Select the function.

9.1.1 The controller is used as a transmitter

Application examples

By creating a radio link between a controller and an output receiver, the following applications can be set up:

- gate opening can switch on lighting to facilitate night time access and gate closing can switch off lighting,
- electrical latch opening can switch on courtesy lighting for a programmable duration,
- etc.

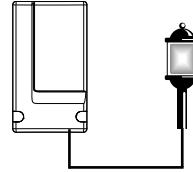
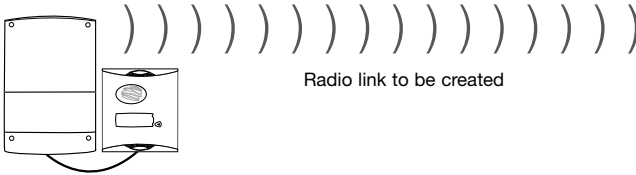

- pressing on the outdoor caller unit call button can trigger a door bell installed elsewhere for a programmable duration.

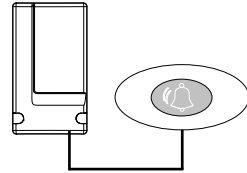
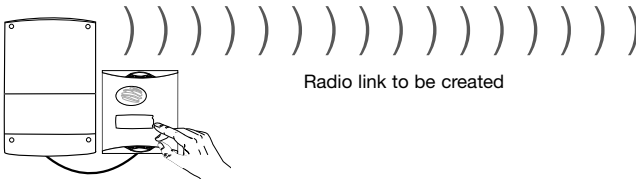

Controller

1. Switch to radio link creation mode.

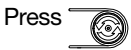

The radio link creation LED lights up orange.

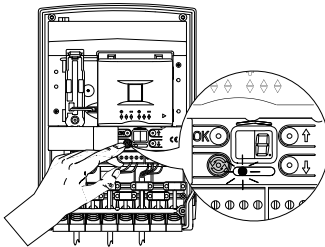

Receiver

2. Switch to radio link creation mode.

3. Select the function.

Information available in the receiver product manual.

Controller

4. Select the event associated with the function.

Using the ,  keys and controller display

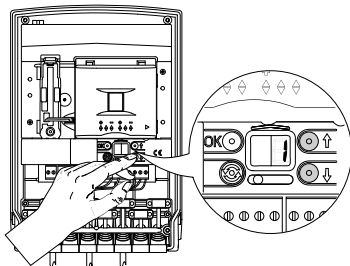

Receiver

Event N°	Event name	Comment
1	Gate opening	This event is displayed when the gate is opened.
2	Gate closed	This event is displayed when the gate closes, as long as limit switches have been wired.
3	Latch opening	This event is displayed when the latch is opened.
4	Side gate closed	This event is displayed when the side gate closes, as long as limit switches have been wired.
5	Day breaking (1)	This event is displayed when the day breaks. Useful for switching off night lighting.
6	Night falling (1)	This event is displayed when the night falls. Useful for switching on night lighting.

or

4. Select the key associated with the function.

Press: gate , latch , or cal  on the outdoor caller unit.

IMPORTANT: step 5 is not necessary if the outdoor caller unit gate, latch or call buttons have been selected.

(1) Event only available with an MHF01X or MHF02X caller unit.

5. Validate the procedure.

Press .

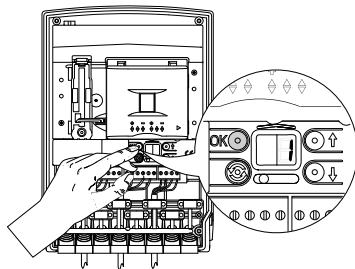

The radio link creation LED lights up green for 2 sec.

Otherwise, start the procedure again.

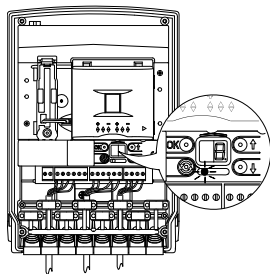

The radio link has been created.



IMPORTANT: if an error occurs, the radio link LED flashes red 3 times. The radio link creation process should be performed again in this case.

9.1.2 The handset is used as a transmitter

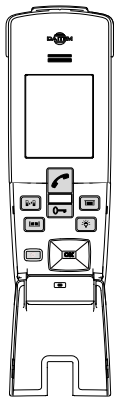

Application examples

By creating a radio link between the  or  keys on the handset and an output receiver, the following applications can be set up:

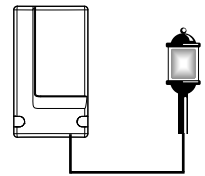
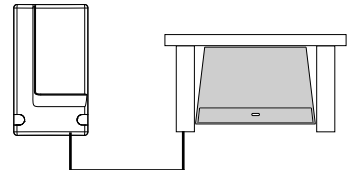
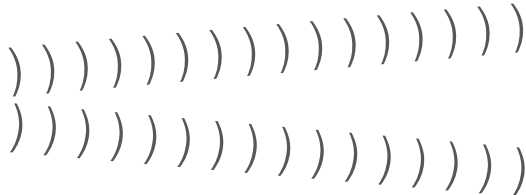

Radio link n° 1,  key
Press once on the  key to open the garage door and press again to close.



Radio link n° 2,  key
Press once on the  key to switch on lighting for a programmable duration.

Handset

Receiver

1. Switch to radio link creation mode.



Display the following screen using the keys

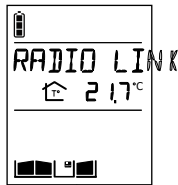

Handset

4. Select the key associated with the function.

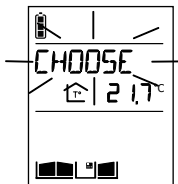

Press on the  or  key.

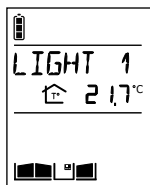
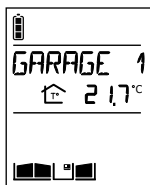

then

Select a command from the following:

GARAGE 1	or	LIGHT 1
GARAGE 2		LIGHT 2
GARAGE 3		LIGHT 3
GARAGE 4		LIGHT 4

Using the keys 

Receiver

2. Switch to radio link creation mode.
3. Select the function.

Information available in the receiver product manual.

5. Validate the procedure.

Press **OK**.

the handset displays:



then



beeps for 2 sec
and

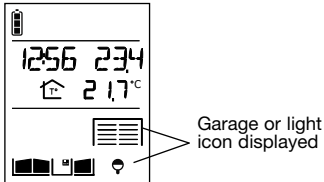

The radio link has been created.

If an error occurs,
the handset displays:

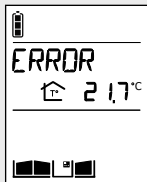

It beeps 3 times
and then
automatically
returns to the
general information
screen:

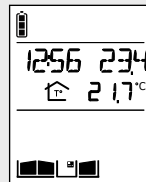

Perform the radio
link creation
procedure again.

9.1.3 The controller is used as a receiver

Transmitter

- 1. Switch to radio link creation mode.

Information available in the transmitter product manual.

Controller

- 2. Switch to radio link creation mode.

Press 

The radio link creation LED lights up orange.

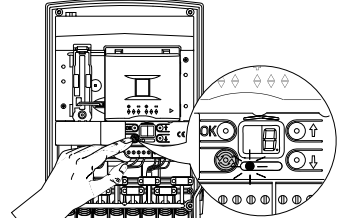

- 3. Select the function.

Using the

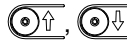

keys and the controller display.

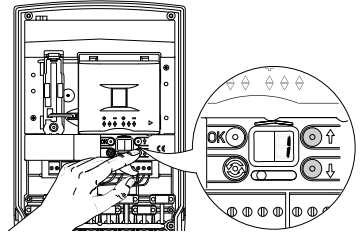

Event N°	Event name	Comment
1	Gate	Triggers the external motorisation system manual control to open the gate.
2	Side gate	Triggers the external motorisation system manual control to open the side gate.
3	Latch	Triggers the controller latch.

- 4. Select the key or event associated with the function.

- 5. Validate the procedure.

Information available in the transmitter product manual.

The radio link creation LED lights up orange. Otherwise, perform the procedure again.

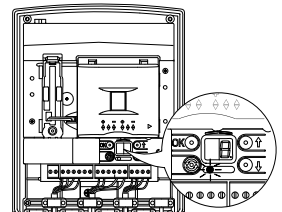

The radio link has been created.

IMPORTANT: if an error occurs, the radio link creation LED flashes red 3 times. Perform the radio link creation procedure again.

Example: operating the controller relay using the  button on the handset.

Handset

1. Put the handset in radio link creation mode.

Display the screen:

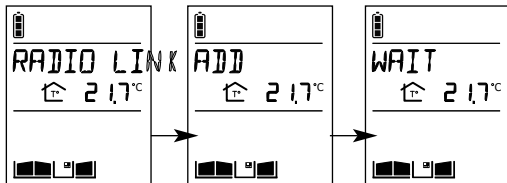

4. Select the key associated with the function.

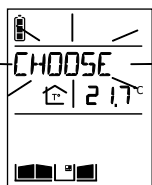

Press 

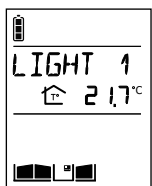

Select the command using 

5. Validate the procedure.

Press .

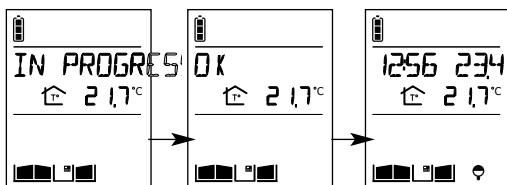

Controller

2. Put the controller in radio link creation mode.

Press 

3. Select the function.

Select function 1 using ,  (1)

The radio link creation LED lights up green for 2 sec.

(1) The relay pulse duration can be adjusted (see ACCES /TIME DELAY menu)

9.1.4 The handset is used as a receiver

Transmitter

1. Switch to radio link creation mode.

Information available in the transmitter product manual.

Handset

2. Switch to radio link creation mode.

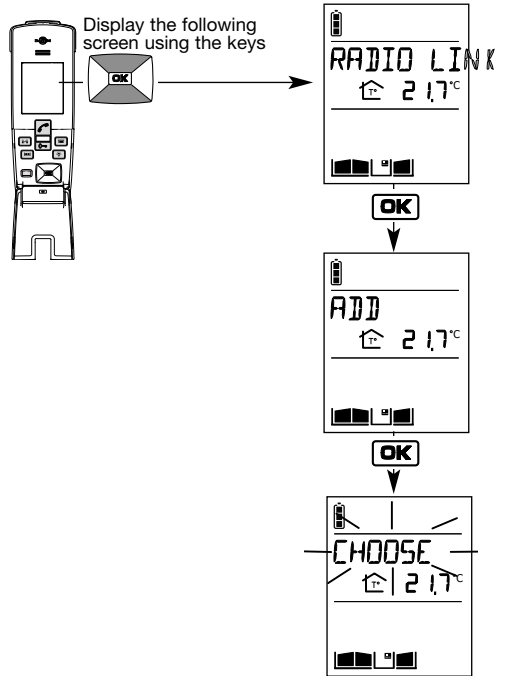

Transmitter

Handset

3. Select the function.

Select one of the 9 ringing tones available using the keys .

The handset displays:



then



beeps every 2 sec
and

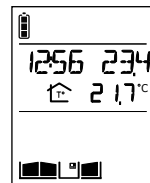

4. Select the key or event associated with the function.

5. Validate the procedure.

Information available in the transmitter product manual.

The radio link has been created.

If an error occurs, the handset displays:

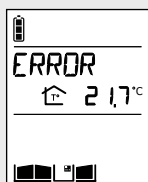

It beeps 3 times and then automatically returns to the general information screen:

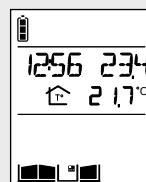

Perform the radio link creation procedure again.

9.1.5 Specific cases

• **Creating a radio link between a handset and several controllers or several outdoor caller unit call buttons.**

A handset can be associated with 4 different inputs. By creating a radio link between the handset and the controller (see chapter on Installing the doorphone), you have created radio link n° 1 (e.g. handset programmed for the 1st call button and input 1).

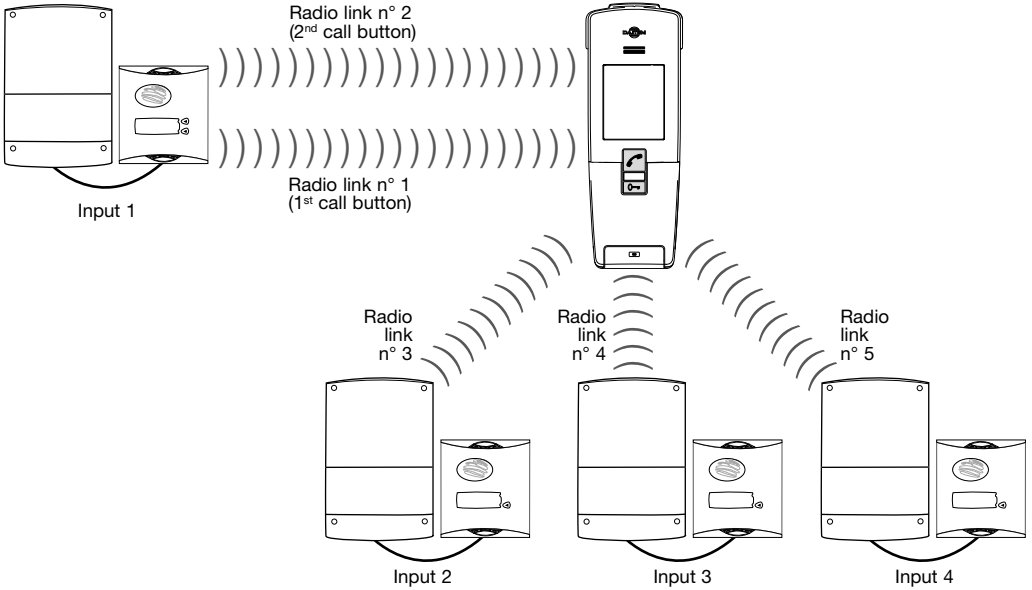

To create radio links n° 2, n° 3, n° 4 and n° 5, follow the procedure below:

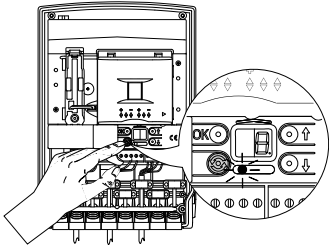
Controller	Handset	Outdoor caller unit
<p>1. Switch the controller to radio link creation mode by pressing </p> <p>The radio link creation LED lights up orange.</p> 		

2. Switch the handset to radio link creation mode.

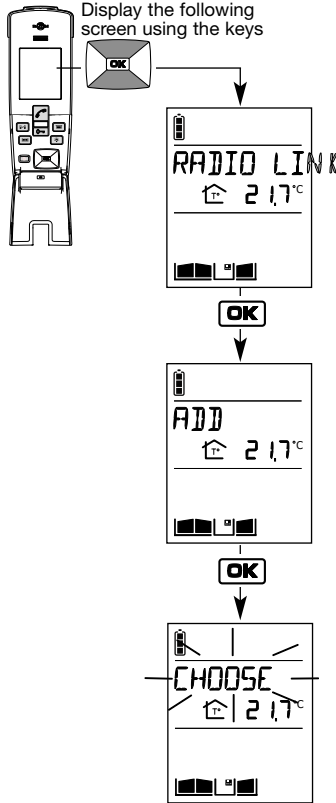

The radio link creation LED flashes orange.

3. Press once on the outdoor caller unit call button to call the handset.

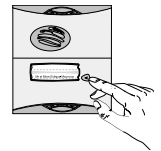

IMPORTANT: if you are using an MHF01X or MHF02X translucent outdoor caller unit and a 1-button armoured cover, only the bottom button (KEY 1) is accessible once the cover is in place.

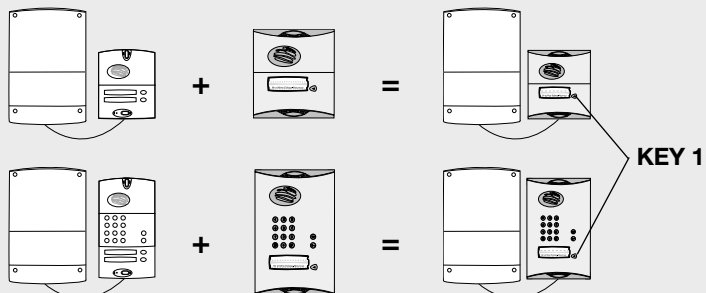

Controller

Handset

Outdoor caller unit

The radio link creation LED lights up green for 2 sec.

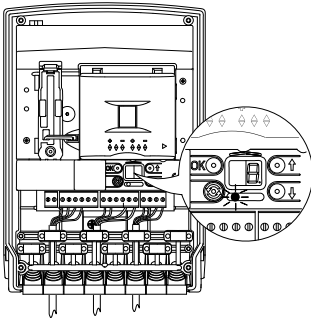

4. The handset displays:

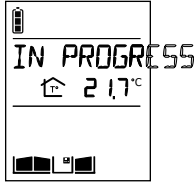

then

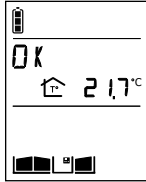

beeps for 2 sec. and

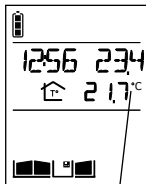

Display of time, indoor and outdoor temperature, gate, side gate or latch status (if position contacts connected).

The outdoor caller unit beeps for 2 sec.

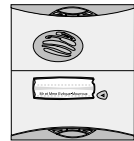

“BEEP”

The radio link has been created.

If an error occurs, the handset displays:

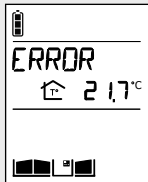

It beeps 3 times and then automatically returns to the general information screen:

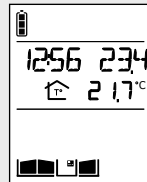

Perform the radio link creation procedure again.

• **Creating a radio link between several handsets**

IMPORTANT: each handset can be linked via radio with a maximum of 7 other handsets.

To allow several handsets to communicate with each other (inter-handset communication), a radio link has to be created between each one.

To do this, proceed as follows:

1st handset

1. Switch the handset to radio link creation mode.

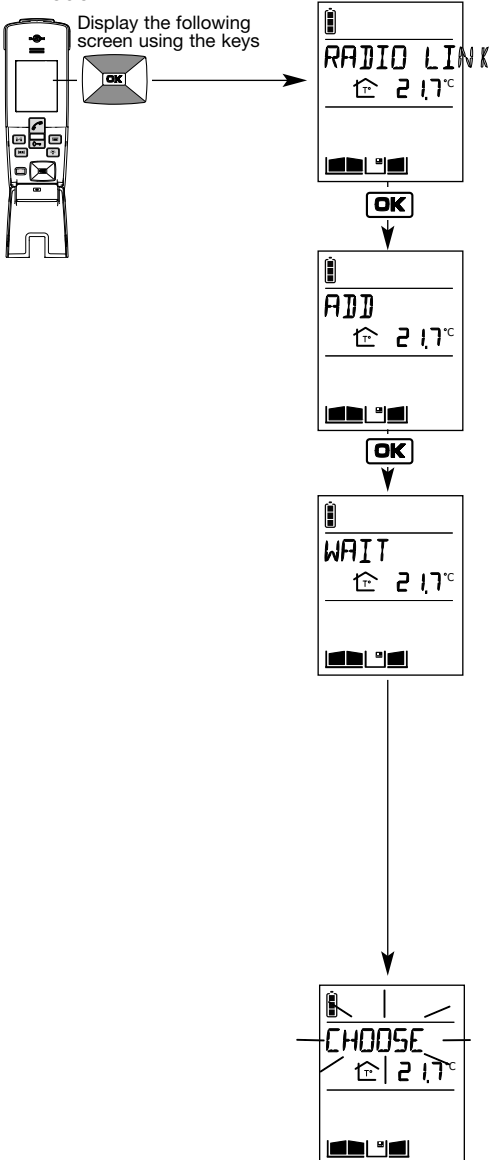

2nd handset

2. Switch to radio link creation mode.

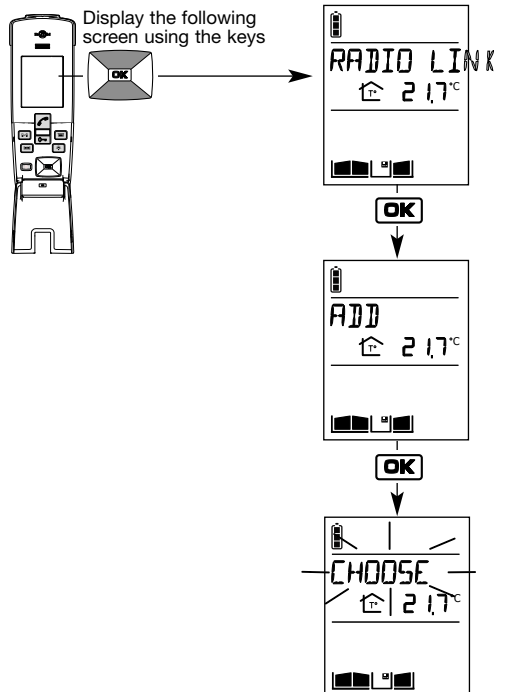

1st handset

3. Press 

4. The handset displays:



then

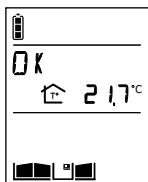

beeps for 2 sec.

and

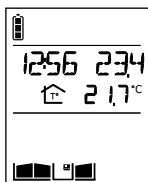

2nd handset

4. The handset displays:



then

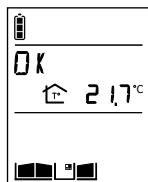

beeps for 2 sec.

and

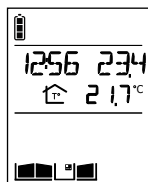

The radio link has been created.

If an error occurs,
the handset displays:

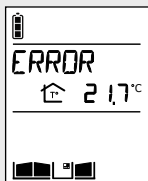

It beeps 3 times
and then
automatically
returns to the
general information
screen:

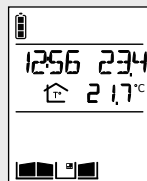

Perform the radio
link creation
procedure again.

9.2 Testing the radio links

This function is used to test the radio links created between a handset and a controller.

To do this, open the controller cover and proceed as follows:

Handset

1. Switch the handset to radio link test mode.

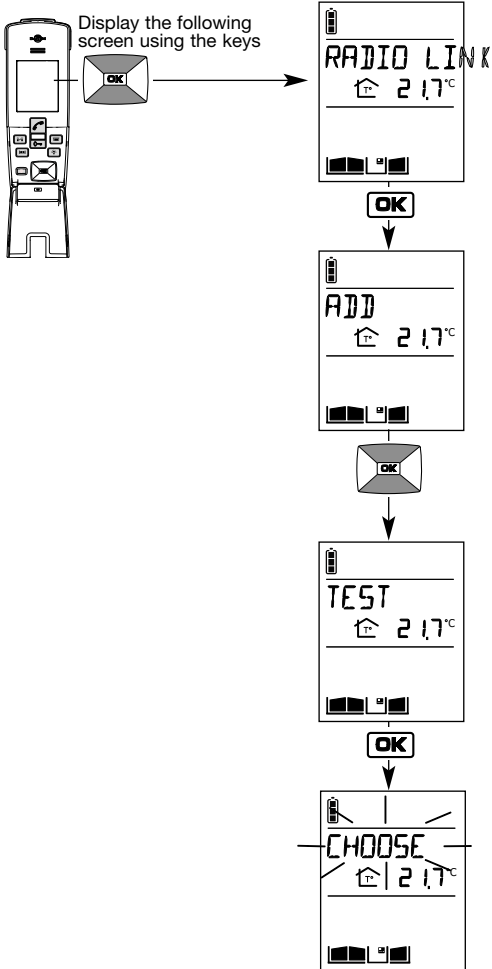

2. Press  or .



Controller

Handset

3. Select the controller to be tested using the keys



4. Press again on





or

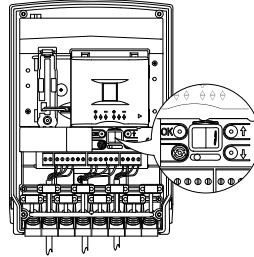

Controller

The controller screen displays "1".



The  key is linked via radio to the controller gate output.

The controller screen displays "2".

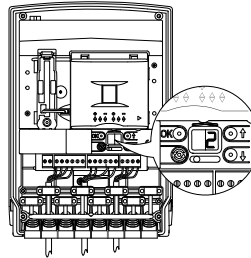

The  key is linked via radio to the controller side gate output.

The controller screen displays "3".

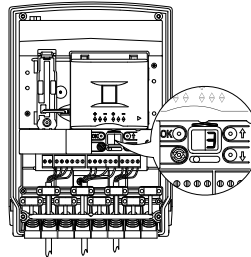

The  key is linked via radio to the controller latch output.

5. Press twice on



The controller beeps 3 times and the display goes out.

6. After several seconds the handset exits radio link test mode and returns to the general information screen.

9.3 Deleting radio links and returning to factory programming

9.3.1 Deleting a radio link between a controller and a handset

This function is used to delete the radio links created between a controller and a handset.

Controller

1. Press 

The radio link creation LED lights up orange.

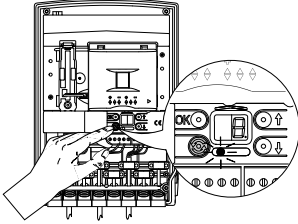

Handset

2. Switch the handset to radio link deletion mode.

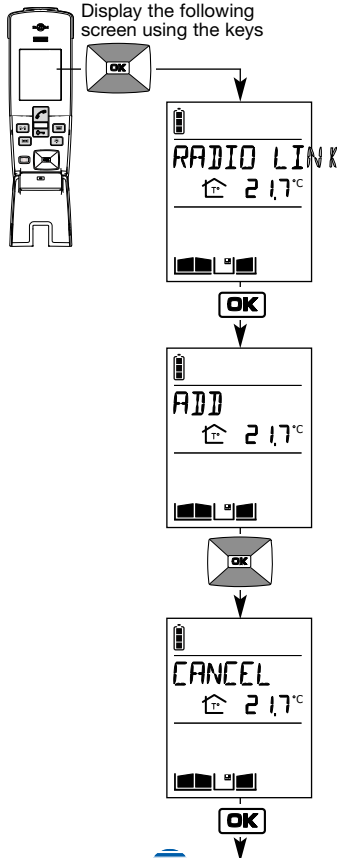

Outdoor caller unit

Controller

The radio link creation LED flashes orange.

Handset

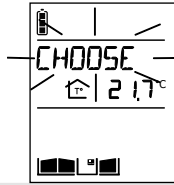

Outdoor caller unit

3. Press once on the outdoor caller unit call button to call the handset.

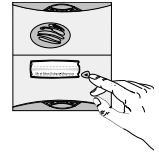

4. The handset displays:

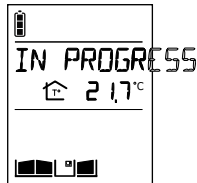

then

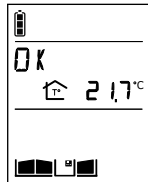

beeps for 2 sec.
and

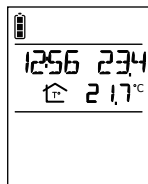

The radio link creation LED lights up green for 2 sec.

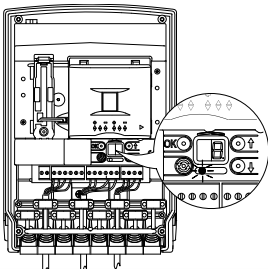

The outdoor caller unit beeps for 2 sec.



"BEEP"

The radio link has been deleted.

If an error occurs, the handset displays:

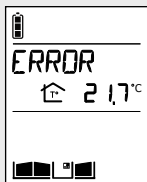

It beeps 3 times and then automatically returns to the general information screen.

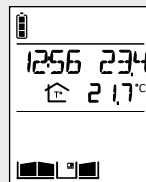

Perform the radio link deletion procedure again.

9.3.2 Returning the handset and controller to factory programming

This procedure is used to delete all the radio links and reset all handset and controller parameters to their factory value.

1. Switch the handset to radio link deletion mode.

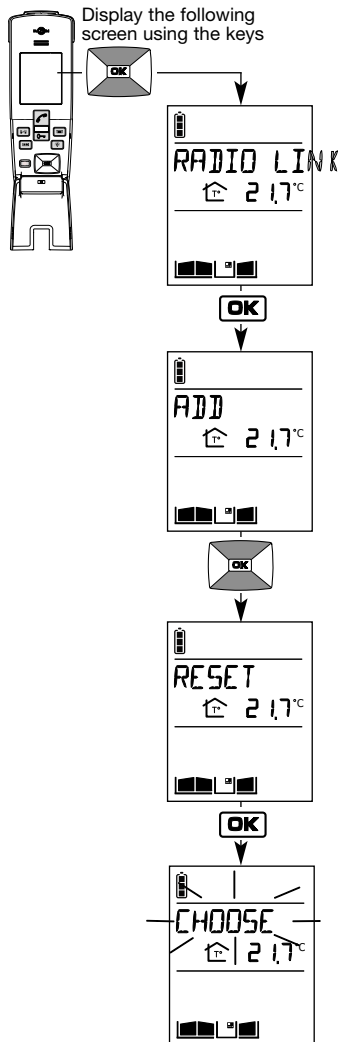

2. Press and hold **OK** until the screen displays OK

The handset displays:

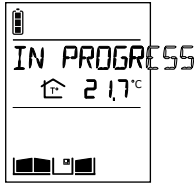

then

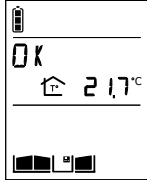

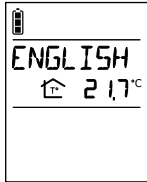

beeps for 2 sec.
and

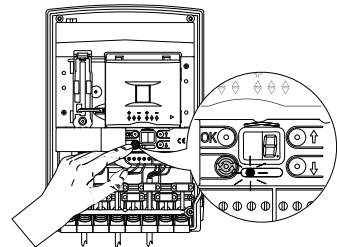

<p>If an error occurs, the handset displays:</p>		<p>It beeps 3 times and then automatically returns to the general information screen.</p>		<p>Perform the radio link deletion procedure again.</p>
--	--	---	--	---

3. Quickly press  and then release the key.



4. Press and hold  for more than 10 sec. until the radio link LED stops flashing red. The LED will then light up green for 2 sec. The outdoor caller unit beeps for 2 sec.

The handset and controller have been returned to their factory settings.

10. Changing the batteries

IMPORTANT

- There is a risk of explosion if the battery/ies is/are not properly replaced.
- Replace the flat battery/ies with the same type.
- Do not expose the battery to excessive heat (e.g. a flame) and do not throw it in a fire.

Dispose of flat batteries in the appropriate waste disposal containers.



10.1 In the controller

When the “BATTERY ACCESS X” message appears, you have 1 month in which to change the batteries of the controller concerned.

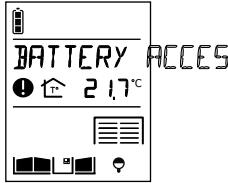

IMPORTANT: disconnect the controller from the electrical network before carrying out any maintenance work.



• Lithium battery

1. Open the controller.

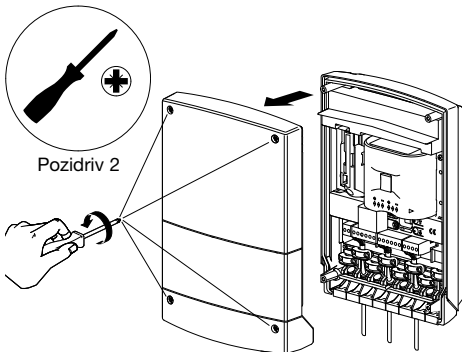

2. Remove the MPU01X battery and then disconnect the other battery.

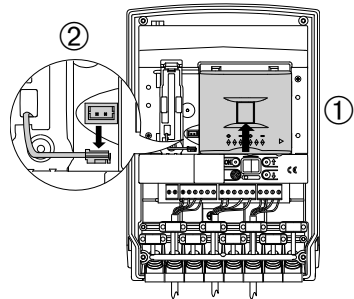

3. Remove the battery enclosure.

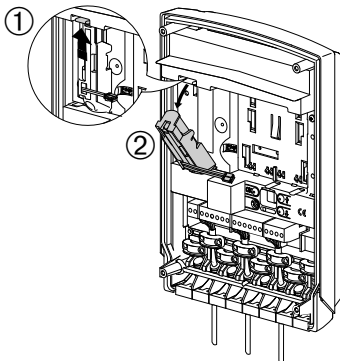

4. Remove the flat battery from its box.

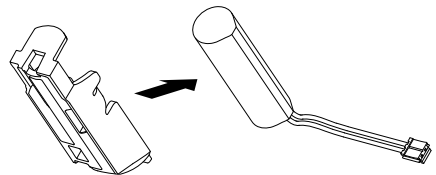

5. Replace it with a new one (ref. 908-21X) making sure to thread the connector through the hole in the enclosure.

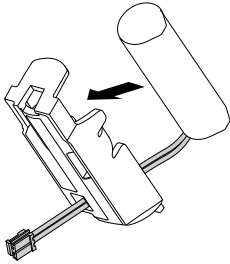

6. Reposition the battery enclosure in the controller.

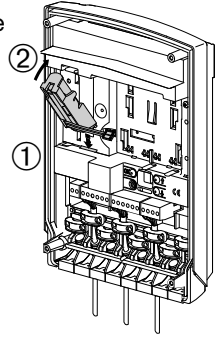

7. Reconnect the battery.

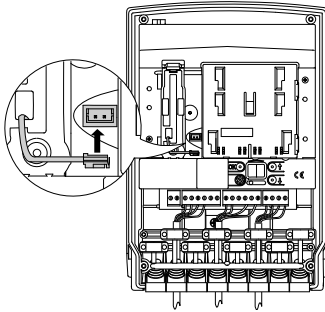

8. Connect a new MPU01X battery.

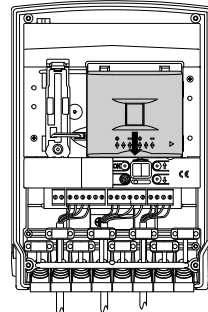

9. When powered, the radio link creation LED lights up red for 2 sec, the outdoor caller unit lights up and also beeps for 2 sec. If this is not the case, check the batteries have been correctly inserted.

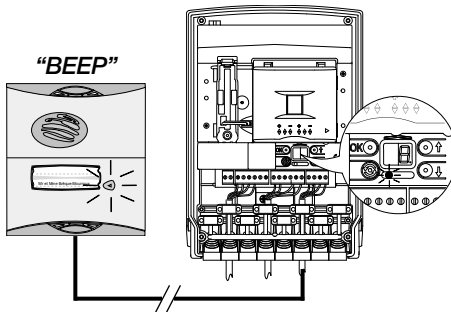

10. Close the controller.

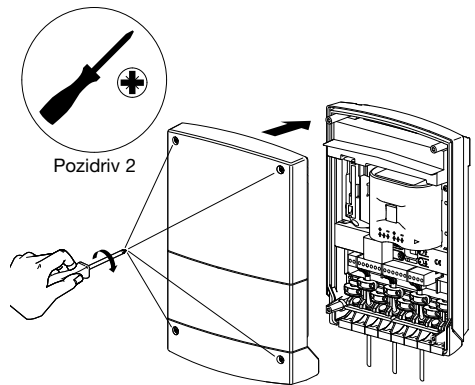

No reprogramming is required after the batteries have been changed.

• **Alkaline batteries**

1. Open the controller.

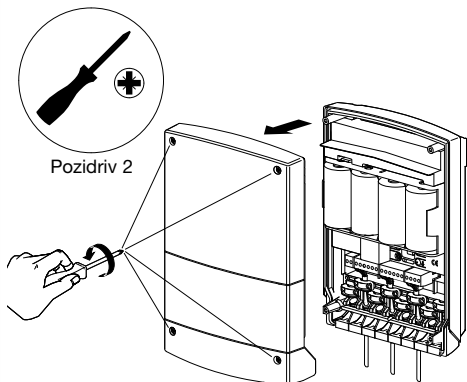

2. Replace the 4 flat LR20 batteries with new ones.

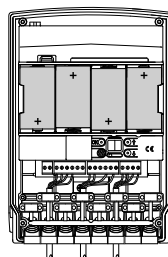

3. When the controller is powered, the radio link LED lights up red for 2 sec, the outdoor caller unit lights up and also beeps for 2 sec. If this is not the case, check the batteries have been correctly inserted.

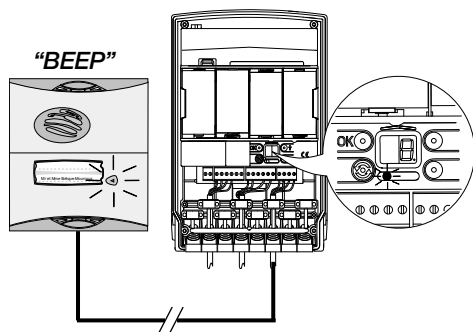

4. Close the controller.

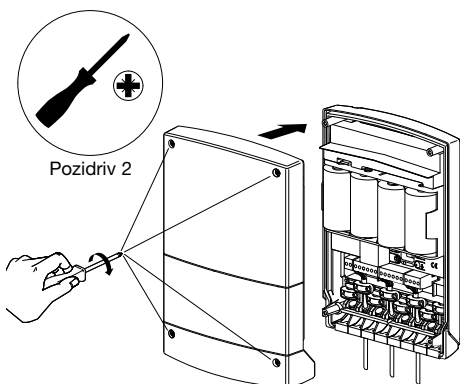

No reprogramming is required after the batteries have been changed.

10.2 In the handset

When you change the controller batteries, it is also advisable to change the handset batteries.

1. Take the handset off its base and remove the belt clip by pressing on one of its sides.

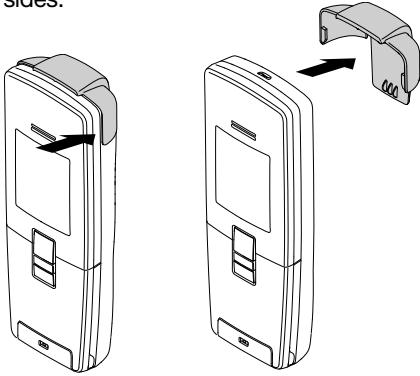

2. Insert a flat screwdriver into the slot and press to open the handset.

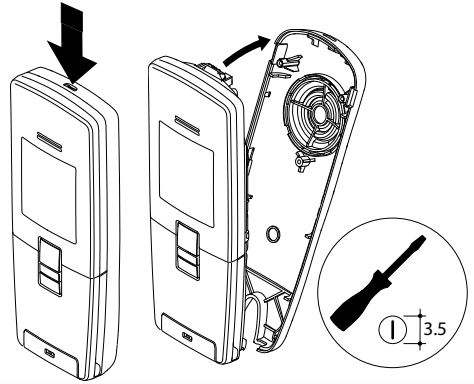

3. Replace the flat MTU01X battery with a new one.

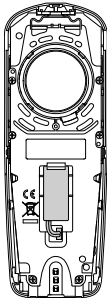

4. Close the handset, put the belt clip back on **and then place the handset back on its base in order to start it up.**

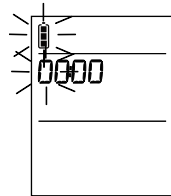

If necessary, the  icon flashes to indicate that the handset is charging.

5. Programme the time using



The temperature display will be updated several minutes after the handset has been powered.

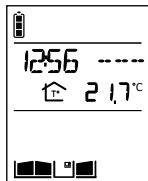

11. Questions - Answers

Questions

Why can conversation be “broken” when using the handset?

What causes the interference (Larsen effect, crackling, etc.) that can be heard in the handset?

Why does the reception quality vary when I move around with the handset?

What should I do if I lose the display on my handset?

What should I do if the handset does not beep and display  when I put it back on its base?

Can I clean my doorphone?

What should I do if the handset does not ring during a communication test?

How should I go about changing controller connections when it has already been operating for several weeks (e.g. to connect a latch)?

Answers

This can happen when you are at the radio reception limit. The controller cuts off communication when you go beyond this limit. You should move closer to the controller.

This can happen when the handset is too close to another handset or the controller. Move the various devices over 3 metres away from each other.

If there is no electromagnetic interference or no obstacle between the handset and the controller, the “free field” radio range is roughly 400 m. When the handset is inside the home, the radio range is less.

Radio wave propagation is limited depending on the type and thickness of the walls or partitions through which they pass.



Trees or bushes
10% to 30% reduction



Plasterboard and wood
10% to 30% reduction



Brick
30% to 50% reduction



Concrete and breeze-block
50% to 70% reduction

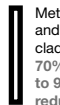

Metal and metal cladding
70% to 90% reduction

Simply recharge the handset on its base. The time must be reprogrammed (HANDSET/SETTINGS/TIME menu)

Check the mains power supply.

Use soapy water and a soft cloth to clean products whenever necessary.

Do not use alcohol or acetone to clean them.

- Check the radio range (see Testing the radio range) and move closer to the controller if necessary.
- Check that the handset is not in silent mode () icon displayed).

Simply connect the latch or automatic control system without disconnecting the power to the controller. When connecting a latch or position contact, the existing radio links must be recreated (see Appendices/Creating a radio link between a handset and several controllers or several outdoor caller unit call buttons).

Questions	Answers
<p>Why does the handset not display the status of the motorisation system connected?</p>	<p>When a radio link is created between a handset and the controller, the position contact must be closed. If this was not the case when the link was created, it must be deleted and recreated (see Appendices/Deleting radio links and then Creating a radio link between a handset and several controllers or several outdoor caller unit call buttons). For a Daitem brand automatic control system, check the wiring and check for any short-circuits between terminal blocks 9 and 10. For an automatic control system belonging to another brand:</p> <ul style="list-style-type: none"> • check that the position contact is connected to terminal blocks 9 and 10, • when there is a position contact connected, place the gate in a position so that the position contact is closed and check that it is displayed on the screen.
<p>Why does the outdoor caller unit issue 3 error beeps when a tag is held up to it?</p>	<p>The tag has not been registered (see Programming doorphone operating functions).</p>
<p>Why is the “BATTERY ACCESS X” message displayed?</p>	<p>Change the controller batteries (see Appendices/Changing the batteries). It is advisable to change the handset battery at the same time.</p>
<p>Why is the “CHARGE HANDSET” message displayed?</p>	<p>Put the handset on the base to charge it.</p>
<p>Why is the “MEMORY FULL” message displayed when a radio link is created?</p>	<p>The handset’s memory capacity has been reached. Delete some of the radio links (see Appendices/Specific cases/Creating a radio link between several handsets).</p>
<p>Why is communication with another handset impossible?</p>	<p>Check there is a radio link between the handsets (see Appendices/Specific cases/Creating a radio link between several handsets).</p>
<p>What does the  icon displayed on the handset mean?</p>	<p>A visitor came to the outdoor caller unit while you were out. To delete the icon, press on a handset button.</p>
<p>How can I change the access code, e.g. from 4 to 6 digits?</p>	<ul style="list-style-type: none"> • Delete all the programmed codes (ACCESS/CODES/DELETE menu) • Modify the size of the access codes (ACCESS/CODES/SIZE menu) - Reprogramme all the codes (ACCESS/CODES/ADD menu)
<p>What should I do if I cannot operate the latch?</p>	<p>Check the wiring and its characteristics (12 V, 0.5 A max.). If controller base is powered by solar panel or MPU01X, 908-21X battery must be installed. If the latch is an addition to the initial installation, the existing radio link must be deleted and a new one created (see Appendices/Deleting radio links and then Creating a radio link between a handset and several controllers or several outdoor caller unit call buttons).</p>

12. Technical data

General data

- Failsafe multi-frequency radio technology with a free field (1) range of up to 400 m, according to environmental and installation conditions
- High-fidelity digital sound

Outdoor caller unit data

- External boxes made of polycarbonate
- Controller and outdoor caller unit degree of protection: IP54/IK08
- Operating temperature from -20°C to $+70^{\circ}\text{C}$
- Controller power supply: 2 x (3.6 V 17 Ah) MPU01X lithium batteries + 1 x (3.6 V 700 mAh) 908-21X lithium-ion battery and/or 12/24 VAC or 12/30V DC power supply and/or 12 V 8 W min. power solar panel, ref. MJU01X or 4 LR20 type 1.5 V alkaline batteries
- 5-year battery life (with MPU01X battery) or 3-year battery life (with 4 LR20 batteries) (2)
- Wiring using 4 wires between the outdoor caller unit and the controller
- Control and powering of any type of low consumption (0.5 A max.) 12 V latches.
- Control of safety ELV motorisation system able to operate with a 48 V DC/1 A dry contact (relay or switch)
- All controller inputs/outputs are SELV types

Internal handset unit data

- Interior boxes made of ABS
- Degree of protection: IP31/IK04
- Operating temperature from -5°C to $+55^{\circ}\text{C}$
- Base powered by mains supply: via 220 V/6 V transformer
- Rechargeable handset powered by MTU01X plug-in lithium-ion battery
- Rechargeable handset battery life when off base: 15 days (3)
- Battery base battery life: 5 years (3)

(1) The free field range corresponds to the maximum theoretical distance separating the controller and the handset when there are no obstacles in the way (e.g. wall, screen, vegetation, electromagnetic disturbance, etc.) likely to reduce the range.

(2) The battery life is based on household use, i.e.: 2 x 10-second communications, 7 latch commands and 6 gate commands per day for a controller and an outdoor caller unit without digicode, 1 x 10-second communication, 4 latch commands (without outdoor caller unit backlighting) and 5 gate commands (without outdoor caller unit backlighting) per day for a controller and outdoor caller unit with digicode.

(3) The battery life is based on household use, i.e. 2 x 10-second communications, 2 x 10-second inter-handset communications and 6 commands (2 latch commands, 2 gate commands, 1 lighting command, and 1 garage door command) per day. For the rechargeable handset battery life to last its full period (15 days) when off its base, it must be left on its base to charge for at least 2 days when it is first powered or 4 days if the display screen disappears (during which time it can of course be used).

CE **DECLARATION OF CONFORMITY** (GB)
10
 Manufacturer: **Hager Security SAS**
 Address: **F-38926 Crolles Cedex - France**

Product type: **Doorphone**
 Trade mark: **Daitem**

We declare under our sole responsibility that the products to which this declaration relates are compliant with the essential requirements of the following directives:

- **R&TTE Directive: 99/5/CE**
- **Low Voltage Directive: 2006/95/CE**
- **ROHS directive: 2002/95/CE**

in compliance with the following harmonised European standards:

Product reference	SC100AU	SC200AU	SC201AU	SC206AX
EN 300 220-2 V2.1.2	X	X	X	X
EN 60950 (2006)	X	X	X	X
EN 301 489-1 V1.8.1	X	X	X	X

These products can be used in all EU and EEA countries and Switzerland.
 Crolles, 06/05/10
 Signature: Patrick Bernard
 Research & Development Director



CE **DECLARATION OF CONFORMITY** (GB)
10
 Manufacturer: **Hager Security SAS**
 Address: **F-38926 Crolles Cedex - France**

Product type: **Doorphone**
 Trade mark: **Daitem**

We declare under our sole responsibility that the products to which this declaration relates are compliant with the essential requirements of the following directives:

- **R&TTE Directive: 99/5/CE**
- **Low Voltage Directive: 2006/95/CE**
- **ROHS directive: 2002/95/CE**

in compliance with the following harmonised European standards:

Product reference	MHF01X	MHF02X	MHF03X	MHF04X	MHF05X	MHF06X
EN 300 330-2 V1.3.1	X	X	X	X	X	X
EN 60950 (2006)	X	X	X	X	X	X
EN 301 489-1 V1.8.1	X	X	X	X	X	X

These products can be used in all EU and EEA countries and Switzerland.
 Crolles, 06/05/10
 Signature: Patrick Bernard
 Research & Development Director



Non-binding document, subject to modification without notice.

 **Waste processing of electrical and electronic devices at the end of their service life** (Applicable in European Union countries and other European countries with a waste collection system). Used on products or product packaging, this symbol indicates that the product must not be thrown out with household waste. It must be taken to a waste collection point for electrical and electronic product recycling. When you make sure that this product is disposed of in the most appropriate manner, you are helping to protect the environment and human health. If you would like additional information concerning the recycling of this product, please contact your town/city council, nearest waste collection centre or the shop where you bought the product.