

**EXTERNAL RADIOCOMMAND-RECEIVERS**

**FA01357-EN**





INSTALLATION MANUAL

**RBE4230 - RBE4024**

EN English

**IMPORTANT SAFETY INSTRUCTIONS WHEN INSTALLING**  
**WARNING: INCORRECT INSTALLATION MAY RESULT IN SERIOUS HARM, FOLLOW THE INSTALLATION INSTRUCTIONS.**  
**THIS MANUAL IS EXCLUSIVELY INTENDED FOR PROFESSIONAL, SKILLED STAFF**

**KEY**

-  This symbol shows which parts to read carefully.
-  This symbol shows which parts describe safety issues
-  This symbol shows which parts to tell users about.

The measurements, unless otherwise stated, are in millimeters.

**DESCRIPTION**

External four-channel receiver, for radio controlling operators and accessories. Multi-frequency (see table), stores up to 3,000 user/codes. It also manages the S5000/6000/7000 digital keypads and the TSP00 and LT001 sensor transponders.

It features a four-digit display and a Memory Roll card for storing and saving data.

You can remotely program and control the system: via the CRP, or, from a PC USB port, or by downloading free RBE-software from [www.came.com](http://www.came.com).

Transmitter compatibility table:

Frequency	AF card	Series	Transmitters
433.92 MHz	AF43S	ATOMO	All models
		TAM	All models
		TOP	All models
		TWIN	only TW2EE - TW4EE
		S9000 radio keypad	
868.35 MHz	AF868	ATOMO	All models
		ATP	ATP864
		TOP	All models

**Dimensions**

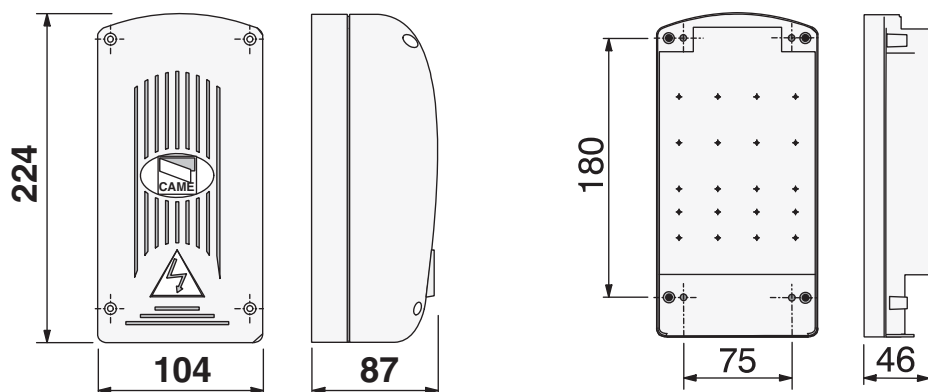

## Technical data

Type	RBE4024	RBE4230
Protection rating (IP)	54	54
Power supply (V)	24 AC/DC	120 - 230 AC
Frequency (Hz)	/	50/60
Stand-by consumption (W)	0.43	0.67 - 0.8
Maximum power (W)	4.4	3 - 3.2
Relay contact rating - resistive load $\cos\phi=1$ (A/V)	5 / 230	5 / 230
Relay contact rating - (A/V) inductive load	1.5 / 230	1.5 / 230
Casing material	ABS	ABS
Operating temperature (°C)	-20 ÷ +55	-20 ÷ +55
Apparatus class	III	II
Weight (Kg)	0.55	0.6

Fuses	RBE4024	RBE4230
LINE FUSE - Line (mA)	315 T	315 T

## INSTALLING

### Fitting

Place the casing where it is protected, and at least five meters from any other receivers; and place the antenna as high and as far as possible from any metal or reinforced concrete structures.

Use  $\varnothing$  6 cylinder head screws and suitable cable glands to ensure the IP is held fast.

Fit suitable cable glands, by drilling the marked inputs under the control panel.

⚠ Be careful not to damage the control board.

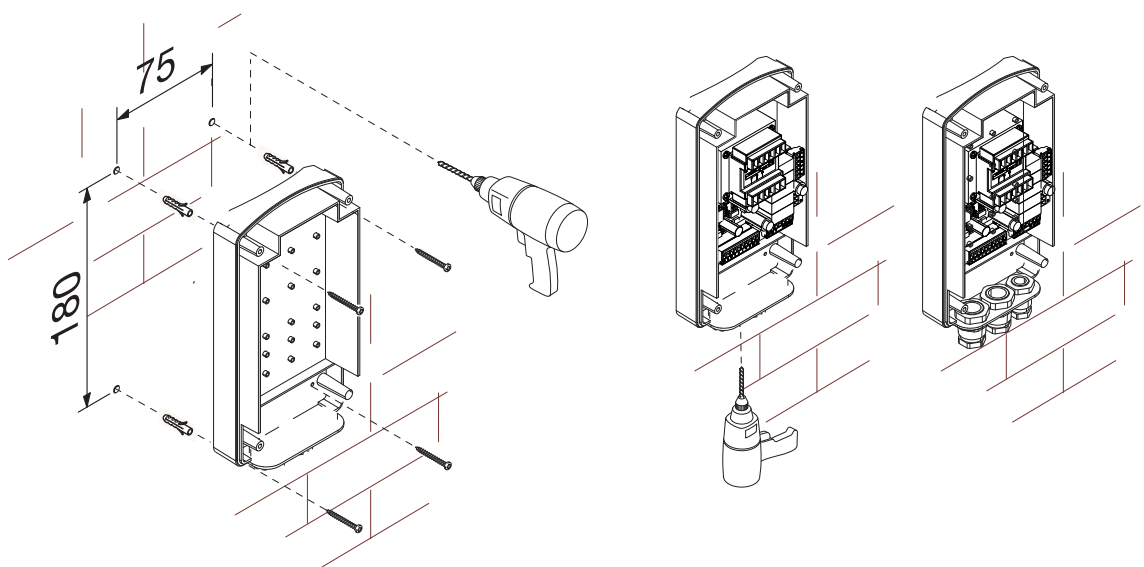

## Board description

1. Power-on LED
2. Programming display
3. Programming Buttons
4. SIPA06 CLOCK control-card connector
5. RSE card connector
6. AF/R700/R800 card connector
7. CRP connection terminals
8. Antenna connection terminals
9. keypad/transponder connector terminals
10. USB connection LED
11. Mini USB connector
12. Terminals for connecting devices to govern
13. Control board power-supply terminals
14. Fuse case
15. Transformer (only RBE4230)
16. Memory Roll card connector

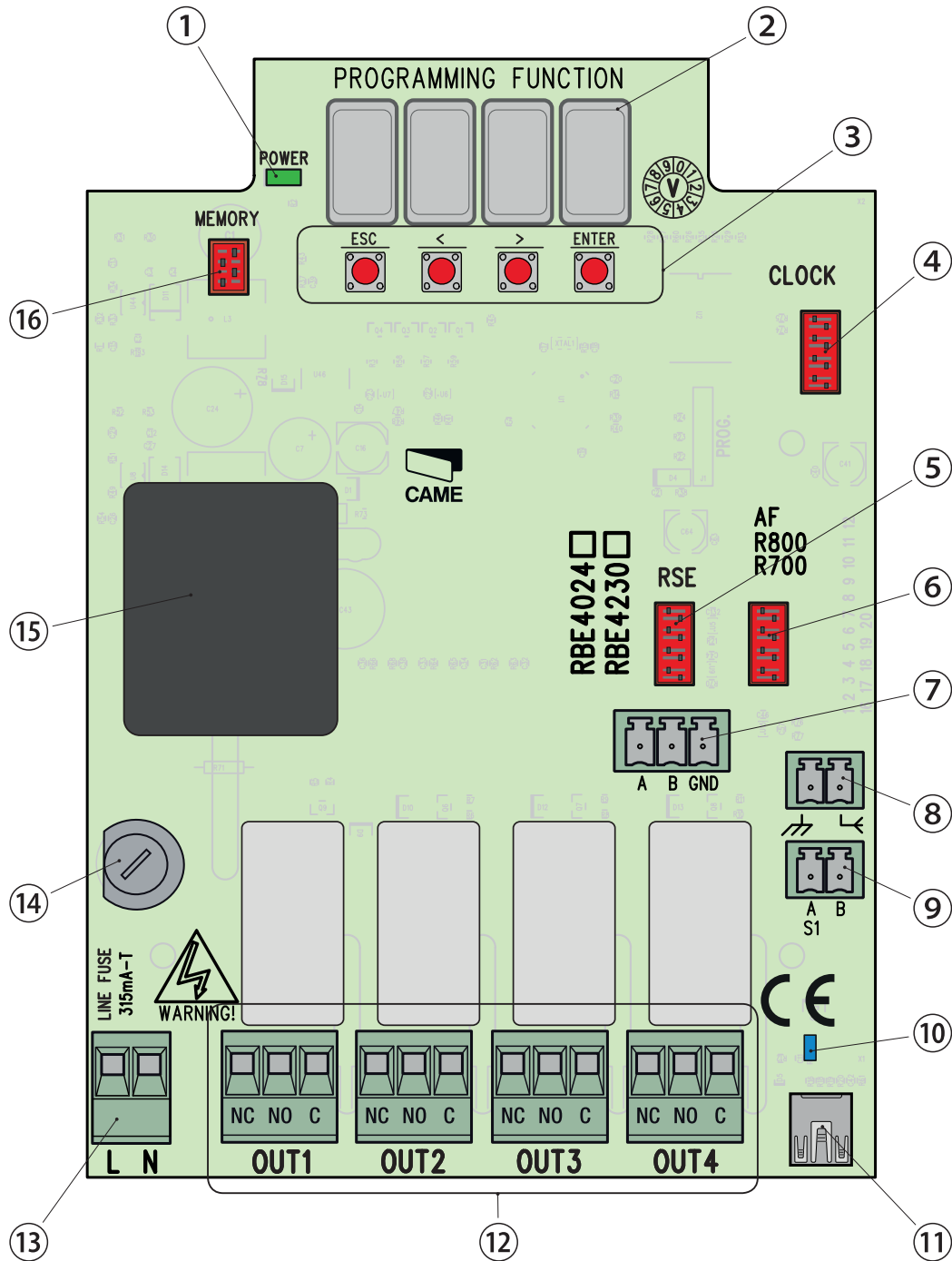

## GENERAL INSTALLATION INDICATIONS

⚠ Only skilled, qualified staff must install this product.

⚠ Warning! Before working on the control panel, cut off the main current supply and, if present, remove any batteries.

### Preliminary checks

⚠ Before installing the control panel, do the following:

- make sure the fastening points and the anchoring surface are solid and protected from impacts. Only use suitable nuts, bolts, dowels, and so on;
- make sure you have set up a suitable dual pole cut off device along the power supply that is compliant with the installation rules. It should completely cut off the power supply according to category III surcharge conditions (that is, with minimum contact openings of 3 mm);
- set up suitable tubes and conduits for the electric cables to pass through, making sure they are protected from any mechanical damage.

### Tools and materials

Make sure you have all the tools and materials you will need for installing in total safety and in compliance with applicable regulations. The figure shows some of the equipment installers will need.

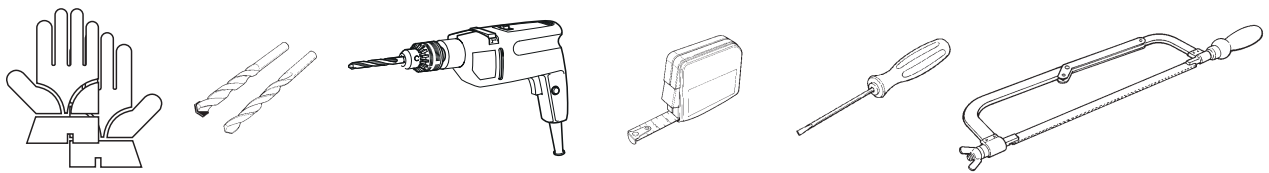

### Cable type and minimum section

Connections	Cable length	
	< 20 m	20 < 30 m
Power supply to the 230 V control board	2G x 1.5 mm <sup>2</sup>	2G x 1.5 mm <sup>2</sup>
Power supply to the 24 V control board	2G x 1.5 mm <sup>2</sup>	2G x 1.5 mm <sup>2</sup>

📖 When operating at 230 V and outdoors, use H05RN-F-type cables that are 60245 IEC 57 (IEC) compliant; whereas indoors, use H05VV-F-type cables that are 60227 IEC 53 (IEC) compliant. For power supplies up to 48 V, you can use FROR 20-22 II-type cables that comply with EN 50267-2-1 (CEI).

To connect to the CRP, use UTP CAT5-type cables up to 1,000 m in length.

Use RG58 cable up to 10 m long to connect the antenna.

📖 If cable lengths differ from those specified in the table, establish the cable sections depending on the actual power draw of the connected devices and according to the provisions of regulation CEI EN 60204-1.

📖 For multiple, sequential loads along the same line, the dimensions on the table need to be recalculated according to the actual power draw and distances. For connecting products that are not contemplated in this manual, see the literature accompanying said products

⚠ Before fitting any plug-in card, such as the AF or R800 one, YOU MUST CUT OFF THE MAINS POWER SUPPLY and, if present, disconnect any batteries.

📖 Once the code-copying procedure is completed, the Memory Roll card must be removed.

### CRP connection with RSE card

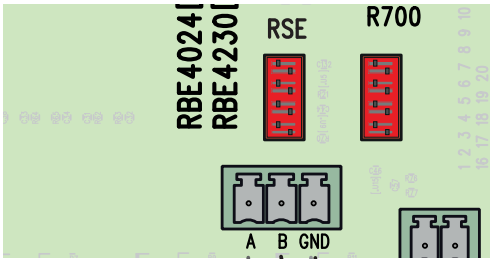

Fit the RSE card.  
Connect to a CAME device running the CRP\* (CameConnect System), as illustrated for the RS485 connection

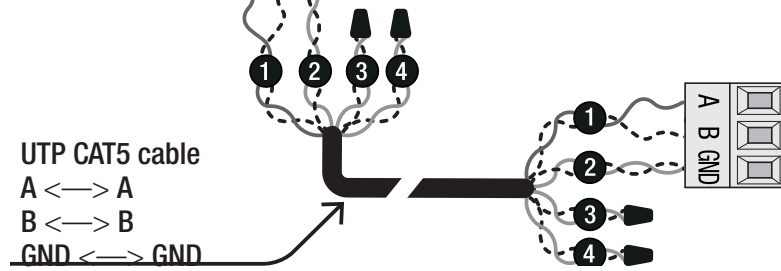

\*To verify compatibility, go to:

[http://www.cameconnect.net/came/docs/cameconnect\\_compliant\\_devices.html](http://www.cameconnect.net/came/docs/cameconnect_compliant_devices.html)

### USB connection

Connect to the AB-type, mini-USB on the PC, to access to the free, RBE\* software advanced functions. You can find these at:

<http://www.came.com/global/en/operators/accessories/rbe4.html>

\* compatible with control card firmware as of the 2.0 version; the one with the H1 function.

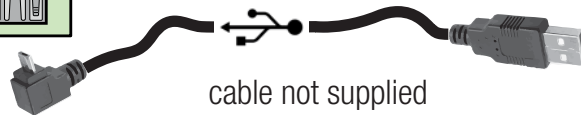
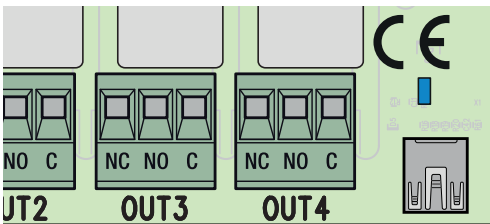

### Antenna connection

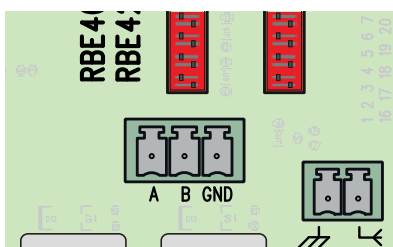

Connect the coaxial cable and antenna brace as shown.

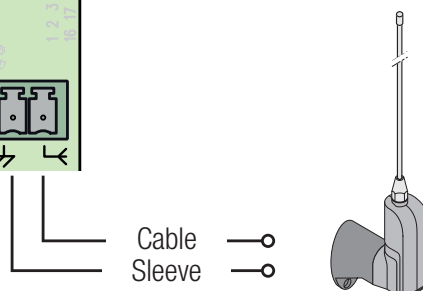

## Transponder connection

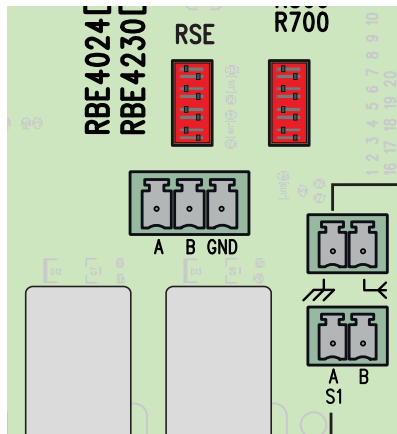

Fit the R700 card.

Connect the transponder sensor or the preferred card reader, while respecting the color code.

Two transponders connected in parallel, maximum.

Black  
Red

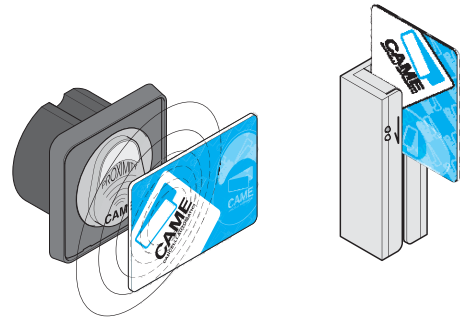

## Keypad connection

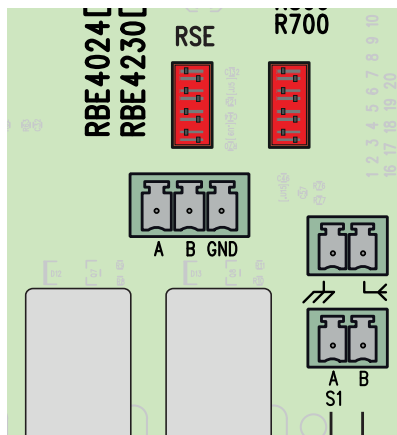

Fit the R800 card.

Connect the preferred keypad, while respecting the color code.

Five keypads connected in parallel, maximum.

Blue  
White



## PROGRAMMING

The key is **ENTER** for

- entering the programming
- entering single menus
- confirming/saving the values you have set

The keys **<>** are for

- moving from one item to another
- increasing or decreasing values

The key is **ESC** for exiting the menus without saving any changes

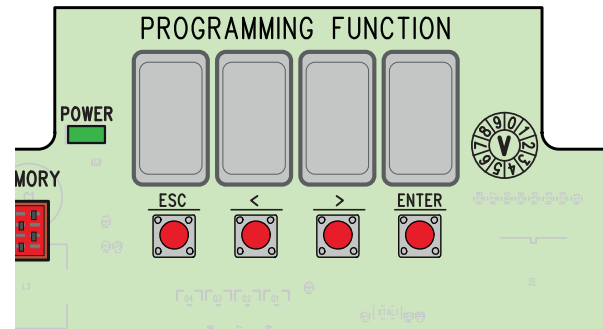

### Menu map

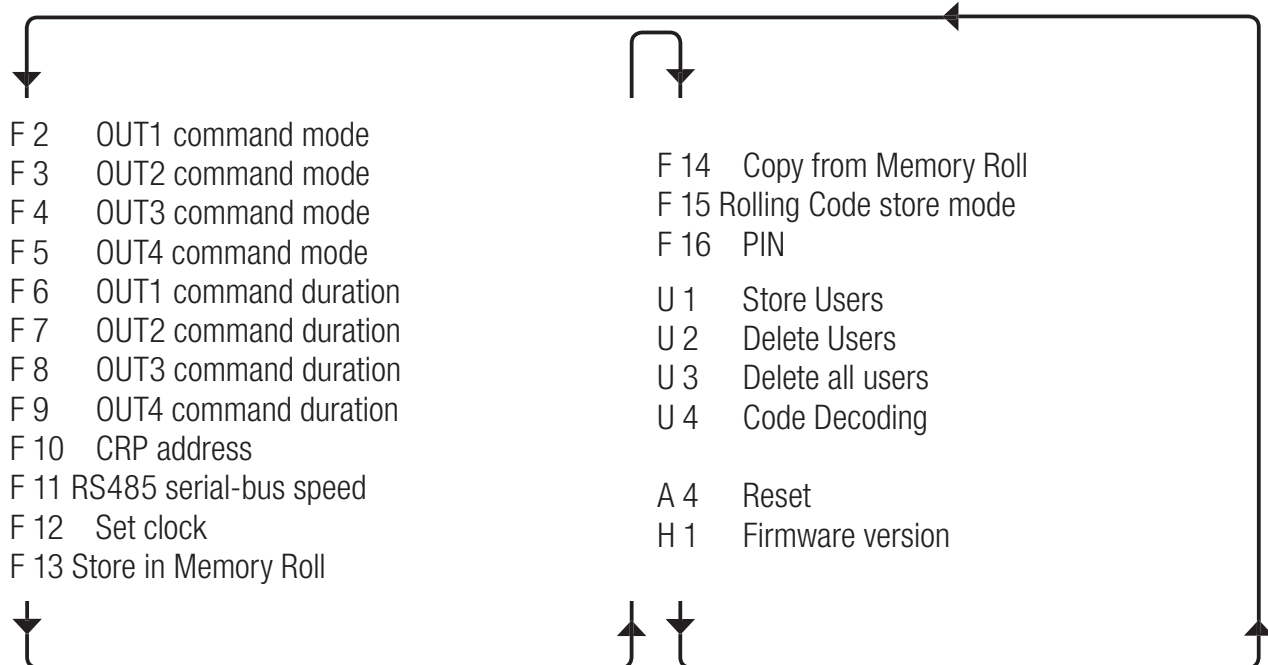

Function	Description ( <i>the default values appear with a black backdrop</i> )
	<b>OUT1 command mode.</b> To choose the output's command mode.
	[ 7 ] Maintained Action Mode.
F 2	[ 2 ] Timer Mode 1 <--> 60 seconds.
	[ 3 ] Timer Mode 1 <--> 180 minutes.
	[ 4 ] Step-by-Step Mode.
F 3	<b>OUT2 command mode.</b> See [ F 2 ].
F 4	<b>OUT3 command mode.</b> See [ F 2 ].
F 5	<b>OUT4 command mode.</b> See [ F 2 ].
F 6	<b>OUT1 command duration.</b> To set the duration of the timer command, if it is set.
	[ 1 ]...<-->...[ 60 ] Seconds / [ 1 ]...<-->...[ 180 ] Minutes
F 7	<b>OUT2 command duration.</b> See [ F 6 ].
F 8	<b>OUT3 command duration.</b> See [ F 6 ].



Function	Description (the default values appear with a black backdrop)
<b>F 9</b>	<b>OUT4 command duration.</b> See [ F 6 ].
<b>F 10</b>	<b>CRP address.</b> Assigning a univocal logic address for managing the receiver via CRP. [ 1 ] ..... [ 255 ] window
<b>F 11</b>	<b>RS485 serial bus speed.</b> To set the speed on the COM port. [ 0 ] window 1200 Baud; [ 1 ] 2400 Baud; [ 2 ] 4800 Baud; [ 3 ] 9600 Baud; [ 4 ] 14400 Baud; [ 5 ] 19200 Baud; [ 6 ] 38400 Baud; [ 7 ] 57600 Baud; [ 8 ] 115200 Baud.
<b>F 12</b>	<b>Setting the clock.</b> See detail in the corresponding chapter. It only appears when the SIPA06 card is fitted.
<b>F 13</b>	<b>Store in Memory Roll.</b> To save the settings of stored users. [ 0 ]; [ 1 ] Store.
<b>F 14</b>	<b>Copy from Memory Roll.</b> To retrieve stored settings and users. [ 0 ]; [ 1 ] Copy.
<b>F 15</b>	<b>Rolling Code store mode.</b> See detail in corresponding chapter.
<b>F 16</b>	<b>PIN.</b> See detail in corresponding chapter.
<b>U 1</b>	<b>Store users.</b> See detail in corresponding chapter.
<b>U 2</b>	<b>Delete users.</b> See detail in corresponding chapter.
<b>U 3</b>	<b>Delete all users.</b> See detail in corresponding chapter.
<b>U 4</b>	<b>Code Decoding.</b> For choosing the type of receiving control code: [ 1 ] All series. [ 2 ] Only Rolling Code series. [ 3 ] Only TWIN series [ 4 ] Keypad. [ 5 ] Transponder. ⚠ When you select a radio code, all saved transmitters will automatically be deleted. <ul style="list-style-type: none"> <li>• The TWIN coding lets you save multiple users with the same key (Key block).</li> </ul>
<b>A 4</b>	<b>Reset.</b> To restore all default parameters. [ 0 ]; [ 1 ] Reset.
<b>H 1</b>	<b>Firmware version.</b>

## F 12 - Setting the Clock

- Enter the programming, select Setting the Clock [F12] and then [1].

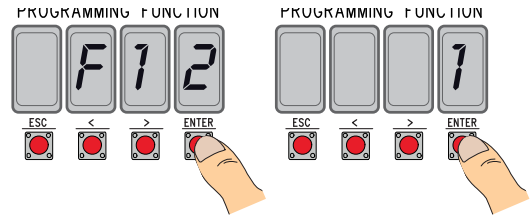

- They will appear sequentially and flashing (</> to vary, ENTER to confirm):

the year (2015), the month (012), the day (031), the day of the week (0007);

the time (0023), the minutes (0059), the seconds (0059);

the standard time (0000 winter time/0001 daylight savings time);

the subsequent calibration of the set time (0000/0001 to activate it).

We suggest that you wait at least one month before checking whether the setting is right.

## F 15 - Store in Rolling Code mode

By default [1], to add Rolling Code transmitters, you need to access the control board and run the [U1] procedure.

By selecting [0] you can store the transmitters that you want to add, and use an already stored transmitter as a key (please, see the transmitter's packaging).

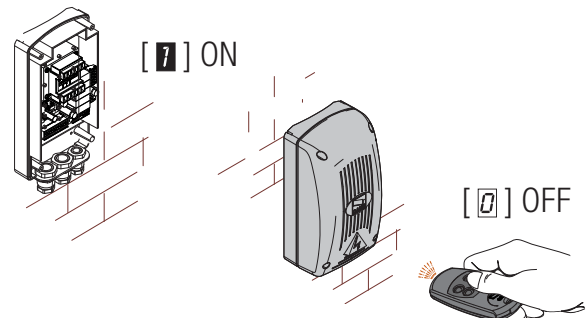

## F 16 - PIN

For protection against tampering and unwanted programming.

- Got to Programming, click on PIN [F16] and then click on [1].

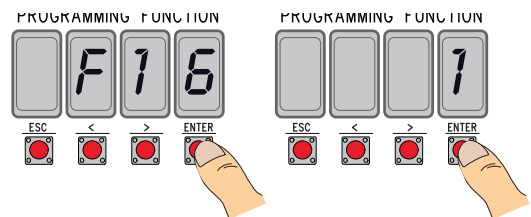

- The default PIN, 1234, will appear. The first number will be flashing. To change the PIN:

[</>] to change the number;

[ESC] to move to the next digit;

[ENTER] to end and confirm the PIN (at any time).

the display will read [Sto] to confirm that the date has been stored.

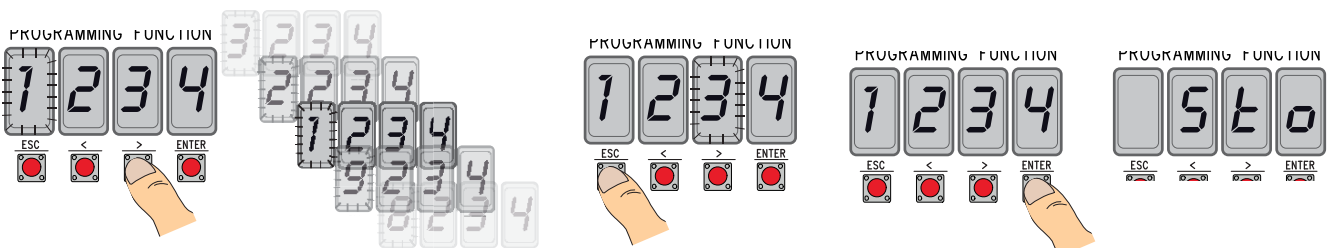

## U 1 - Store Users (max. 3,000)

Storing a user transmitter is always associated to a control mode (see functions [F 2]/[F 3]/[F 4]/[F 5]).

 Remove the Memory Roll card, before proceeding.

- Enter the programming, select Store Users [U1].
- Choose which relay to associate to the code [1]/[2]/[3]/[4].

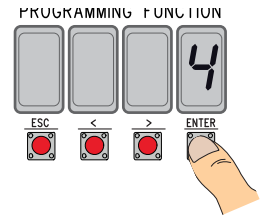
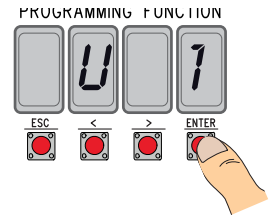

- The first available position for storing will appear.  
 The available positions are the flashing ones.

- Send the code by using the transmitter (even in sequence), the [Sto] wording will appear to confirm it have been saved.  
 When the maximum number of users is reached, the wording [FULL], will appear.



## U 2 - Delete users

- Enter the programming, select Delete Users [U2] and then [1].

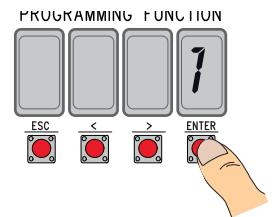
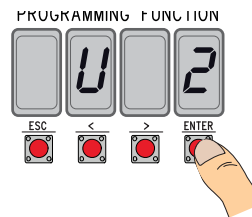

- The wording [3000] will appear.  
Select the user to delete and press [ENTER]:

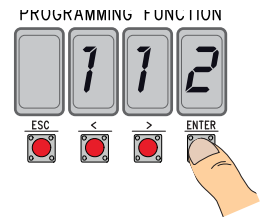
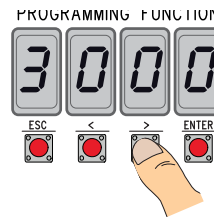

- The display will show the [CLr] wording to confirm that the single user has been deleted. and the corresponding numbering will start flashing: select the next user or exit the procedure by using [ESC]



## U 3 - Delete all users

- Enter the programming, select Delete All Users [U3] and then [1].
- All stored users will scroll in rapid sequence and at the end the display will show the [CLr] wording to confirm that all users have been deleted.

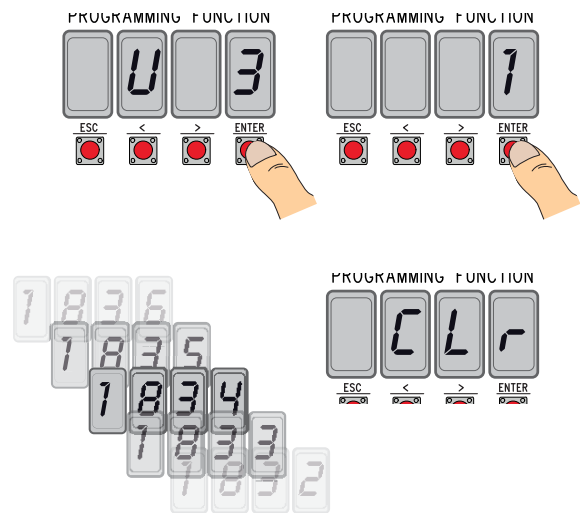

## DISMANTLING AND DISPOSAL

Always make sure you comply with local laws before dismantling and disposing of the product. The packaging materials (cardboard, plastic, and so on) should be disposed of as solid household waste, and simply separated from other waste for recycling.

Whereas other components (control boards, batteries, transmitters, and so on) may contain hazardous pollutants. These must therefore be disposed of by authorized, certified professional services.  
DISPOSE OF RESPONSIBLY!

## REFERENCE REGULATIONS

CAME SpA declares that this product complies with the current directives at the time it is manufactured.

## List of registered users

1/.....

1	
2	
3	
4	
5	
6	
7	
8	
9	
10	
11	
12	
13	
14	
15	
16	
17	
18	
19	
20	
21	
22	
23	
24	
25	
26	
27	
28	
29	
30	
31	
32	
33	
34	
35	
36	
37	
38	
39	
40	
41	
42	
43	

44	
45	
46	
47	
48	
49	
50	
51	
52	
53	
54	
55	
56	
57	
58	
59	
60	
61	
62	
63	
64	
65	
66	
67	
68	
69	
70	
71	
72	
73	
74	
75	
76	
77	
78	
79	
80	
81	
82	
83	
84	
85	
86	







[CAME.COM](http://CAME.COM)

**CAME S.P.A.**

Via Martiri Della Libertà, 15

31030 Dosson di Casier - Treviso - Italy

tel. (+39) 0422 4940 - fax. (+39) 0422 4941