

GT8-6M-KIT



CAME 

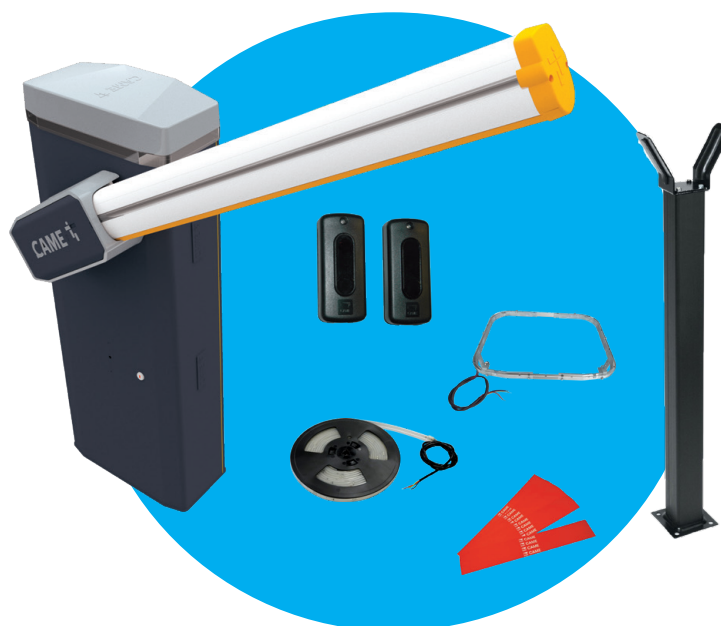

24V DELUXE BARRIER KIT

Road widths up to 5.65m



Code	Description	Quantity
803BB-0180 	GGT80AGS - Automatic barrier with 24 V DC operator with encoder; galvanized steel and painted cabinet with set up for fitting accessories. Balancing springs included.	1
803XA-0410C	White painted aluminum boom, 130 x 85 mm, with internal reinforcement, groove cover-strip and shock-proof rubber profile. Length: 6000 mm.	1
803XA-0430	Luminous red/green LED crown.	1
803XA-0240	Red/green LED strips for booms up to 4-m long.	1
001 G02807	Fixed rest.	1
001 G02809	Package of 20 red, reflective, adhesive strips.	1
001 DIR10 	Pair of 12 - 24 V AC - DC outdoor photocells – range 10 m.	1



GGT80AGS

Net clearance up to 4 m



Ideal solution for applying in private homes and industrial plants

- 24 V DC operator with Advanced Speed Control.
- Tested for intensive use of 160 cycles/hour with MCBF 3 million cycles.
- Cabinet available in galvanized steel and painted RAL7024, AISI 304 and AISI 316 steel, or in customized color.
- Control board with display, CONNECT technology and inputs for CXN BUS accessories.
- Accessories that can be integrated directly into the cabinet.
- High visibility red/green LEDs on the crown and on both sides of the boom.
- It can be integrated with third party systems through MODBUS protocol.

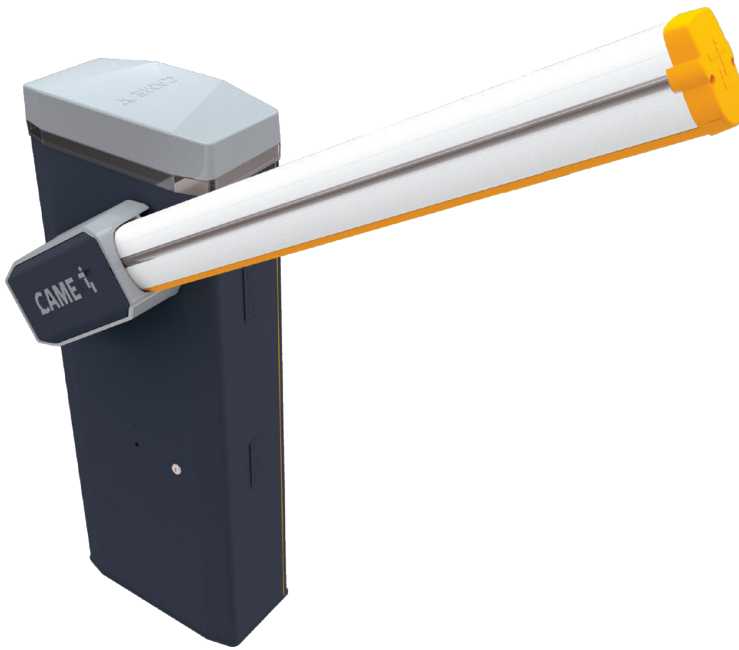

Dimensions (mm)

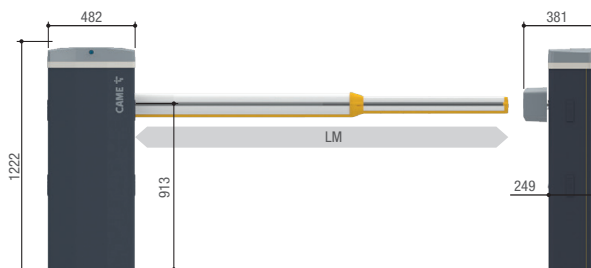

LM = Max. net clearance width

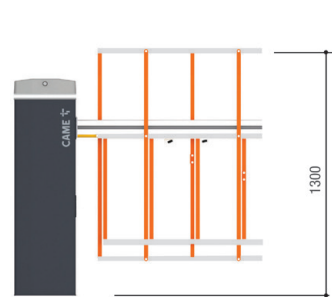

803XA-0350

Operational limits

MODELS	803BB-0180
Max. net clearance width (m)	7,8

Technical characteristics

MODELS	803BB-0180
Protection rating (IP)	54
Power supply (V - 50/60 Hz)	230 AC
Power supply to motor (V)	24 DC
Power (W)	300
Opening time at 90° (s)	4 ÷ 8
Cycles/Hour	160
Operating temperature (°C)	-20 ÷ +55 (-40 with item 001PSRT01)

ACCESSORIES

803XA-0410C

Aluminium boom



White painted aluminum boom, 130 x 85 mm, with internal reinforcement, groove cover-strip and shock-proof rubber profile. Length: 6000 mm.

G02807

Fixed rest

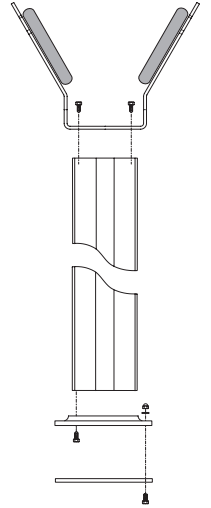
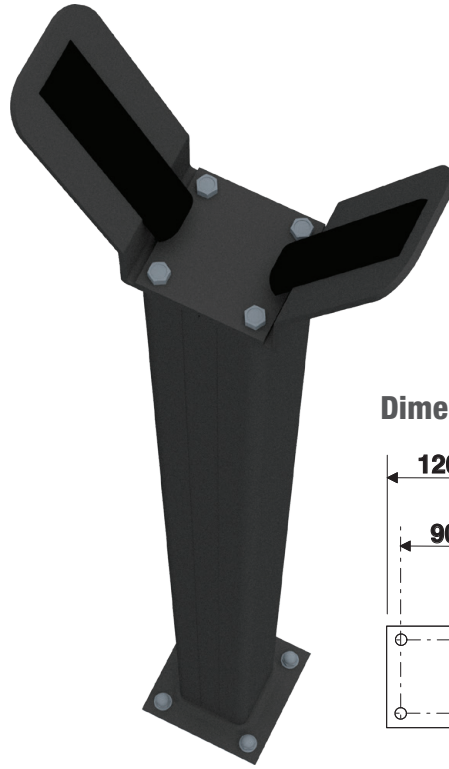

Dimensions of base (mm)

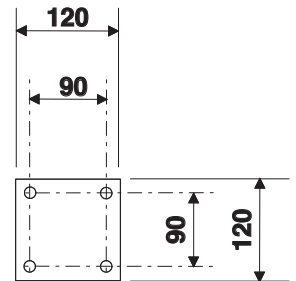

803XA-0430

Luminous red/green crown



803XA-0240

Red/green LED strips for booms up to 6.5m long



ACCESSORIES

G02809

Package of 20 red, reflective, adhesive strips



DIR10

Photocells



Dimensions (mm)

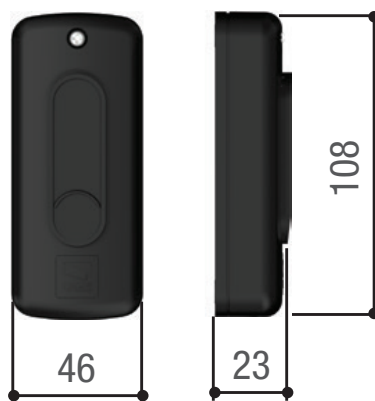

- Control the gate's area of movement
- Infrared beam, even synchronised, to prevent any external signal disturbances.
- For the DIR series photocells, there is a double-height post, and a new PVC version of the post, for installing in entry and exit points where heavy vehicles drive through.
- High degree of protection against weathering.

Operational limits

MODELS	DIR10
Max. range of radio (m)	10

Technical characteristics

MODELS	DIR10
Protection rating (IP)	54
Power supply (V)	12 - 24 AC - DC
Absorption	60
Max. rating of 24 V (A) relay contacts	0,5
Operating temperature (°C)	-20 ÷ +55
Material	ABS - POLYCARBONATE