

Installation & User Instructions

Praetorian Guard IP Intercom

PROFESSIONAL INSTALL ONLY



Manual Version 1.1

Tip: Site Survey BEFORE you begin.
See page 4-5



WARNING

Do not power from the gate controller. Only use the provided UL power supply, otherwise damage may occur and warranty may be void.

Index

Section	Pages
PHASE 1 – SITE SURVEY	4-5
Site Survey (LAN)	4
Site Survey (WiFi)	5
PHASE 2 – PRODUCT OVERVIEW	6-14
Overview of Call Points	7-10
Overview of Optional Extra Devices	11
More Detail....	12-14
PCB Module Overview	15
Technical Specifications	16-18
PHASE 3 - SETUP	19-30
Configure Before Install	19
Connect to network using WiFi	20-24
Connect to network using LAN Cable	25-26
Time Sync & Testing	27-28
Answering on Android	29
Answering on iOS (Apple)	30
PHASE 4 - INSTALLATION	31-40
How to Achieve & Maintain IP55 Rating	32
Installation (Wi-Fi) & (LAN Cable)	33
Power & Solar Power	34
LAN Cable & WiFi Setup Example	35
PCB Wiring Example	36
Exit Button (PTE) & Connecting Slave Devices	37
Adding Additional APP Users	38
Sound, Volumes and Speech / Intercom & Device Sound Options	39
Using Keypad Codes	40
PHASE 5 – ADVANCED SETUP	41-52
Feature Shortcuts & Settings Overview	42
Standard Features	43
Edit Intercom Details / Add a New Device ID	44
Ringtones of In-app Call / Check APP version	45
Check Intercom Firmware / Add, Edit or Delete Users & Logins	46
Adjust Relay Trigger Times / Adjust Intercom Time	47
Wi-Fi Settings / Adjust Maximum Monitoring Time	48
Adjust Maximum Talking Time / Adjust Maximum Calling Time	49
Reboot Intercom / Simplex / Duplex Audio Selection	50
Advanced Feature Overview / Notifications	51
Auto Relay Times / Camera Stream Resolution	52
Activity Log	53
Keypad Codes	54
PROX Cards/Tag IDs	55
Voicemail Option for missed Callers / Motion Detection Option	56
Troubleshooting	57-58
App Updates / Firmware Updates / Extra Resources	59
Intercom Maintenance / Environmental Information / Ingress	60
Warranty	61

PHASE 1

Site Survey

Site Survey (LAN)



Upload Speed

I have at least 1.5 Mb **UPLOAD** speed. If not STOP! This system may operate intermittently remotely or have delayed PUSH notifications.

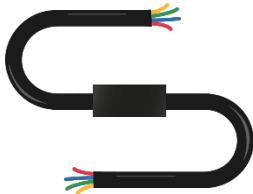

Cable Distance

My cable run does not exceed 100m in total distance. If it does then a powered switch is required to be fitted in-line to extend the signal.

The Praetorian Guard is designed to transmit the video and audio stream using on average 400 KBit/sec (peaking to 1Mbps). This loosely translates to requiring a minimum of **1.5Mbps UPLOAD speed** on the network that the intercom is connected to. The higher the upload speed the better quality of image up to an approx. max of 4Mbps upload speed.

If you do not have sufficient upload speed then please look at upgrading your internet package, if possible.

Please consult someone with network knowledge if you need help with these steps.

Site Survey (Local WiFi)



WiFi Signal

I have some WiFi signal at the gate with my phone! If not, STOP. You will need some form of WiFi extender, or repeater, or LAN/CAT5 cable!



Upload Speed

I have at least 1.5 Mb UPLOAD speed. If not STOP! This system may operate intermittently remotely or have delayed PUSH notifications.



YES!

My WiFi Internet Security is WPA, WPA2, WPA3 or better.

Total distance of WiFi range will depend heavily on the property network setup. Max distance is 60m based on using a basic home router passing through 1 exterior wall. For the most reliable connection utilize the LAN or 4G Router options.

WiFi Signal Explained

Poor = System may not show ONLINE. Signal may drop out regularly or cause delay's on the video loading or stop notifications receiving from being sent.

Fair = System will operate as expected in most instances. Signal may drop out from time to time or cause delay's on the video loading or stop notifications receiving from being sent.

Good / Excellent = System will operate as expected in all instances. Signal should never drop or cause delay's on the video loading

Please consult someone with network knowledge if you need help with these steps.

PHASE 2

Product Overview

Overview of Call Points (Modular Design)



PRAE-IP-MOD



PRAE-IP-MOD-KP



PRAE-IP-MOD-PX



PRAE-IP-MOD-PX-KP

Overview of Call Points (Modular Design)



PRAE-4GXX-MOD-ROUTER



PRAE-4GXX-MOD-KP-ROUTER



PRAE-4GXX-MOD-PX-ROUTER



PRAE-4GXX-MOD-PX-KP-ROUTER

Overview of Call Points (Architecture Design)



PRAE-IP-AB



PRAE-IP-AS



PRAE-IP-ABK



PRAE-IP-ASK



PRAE-IP-PX-ABK



PRAE-IP-PX-ASK

Overview of Call Points (Portrait Flush Design)



PRAE-IP-FB



PRAE-IP-FS



PRAE-4GXX/FBK



PRAE-IP-FSK



PRAE-IP-F-PX-ABK



PRAE-IP-F-PX-ASK

Overview of Call Points (Pedestal Design)



PRAE-IP-PED



PRAE-IP-KP-PED



PRAE-IP-PX-PED



PRAE-IP-PX-KP-PED

Overview of Call Points (Pedestal Flush Design)



No image available

PRAE-IP-PED-F



PRAE-IP-PED-F-KP

Overview of Optional Extra Devices



MON-11



POWER CONDITIONING MODULE



TBC (future addition late 2021)



TBC (future addition late 2021)

More Detail....

Architectural Model

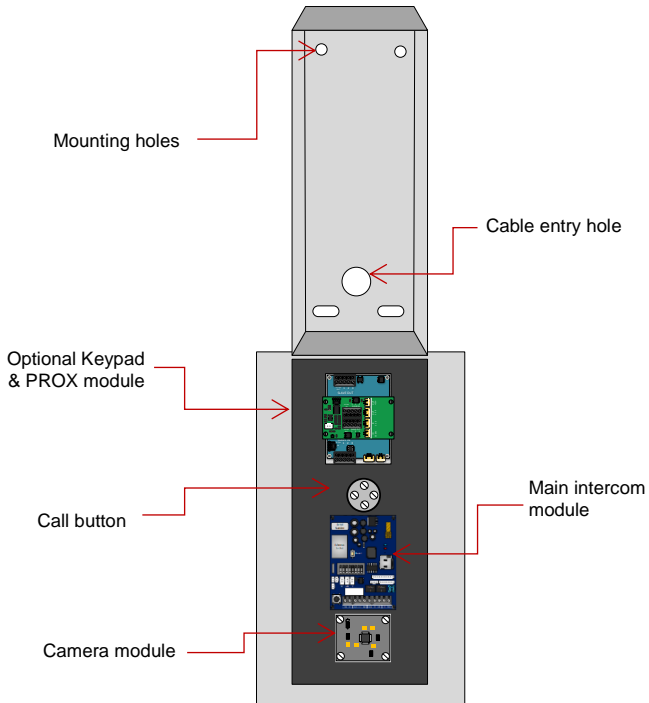
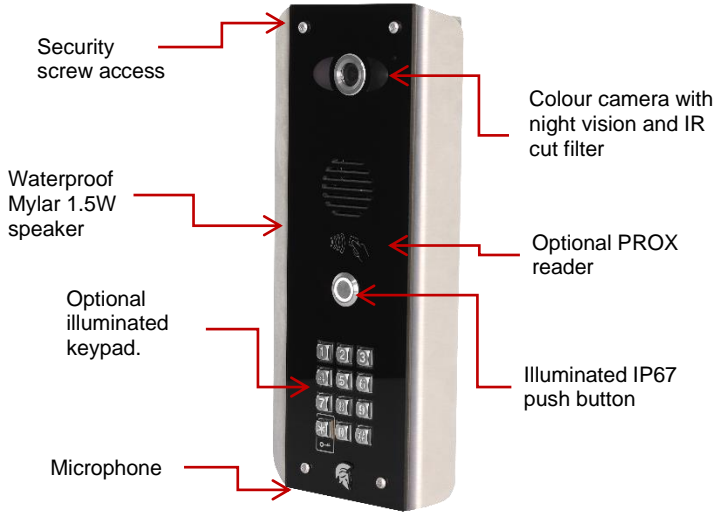

Modular Version

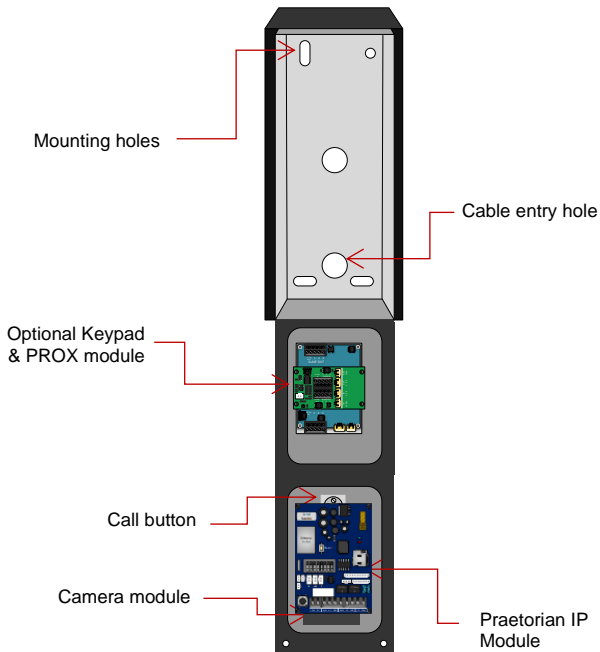
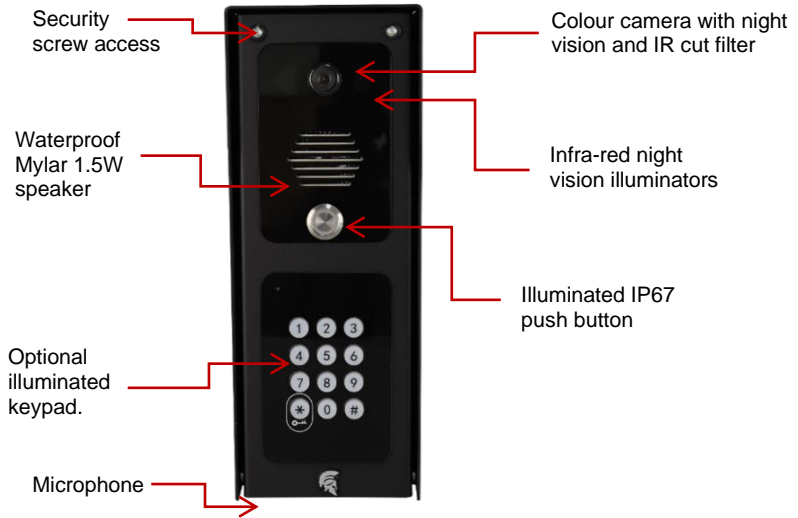

Pedestal Version

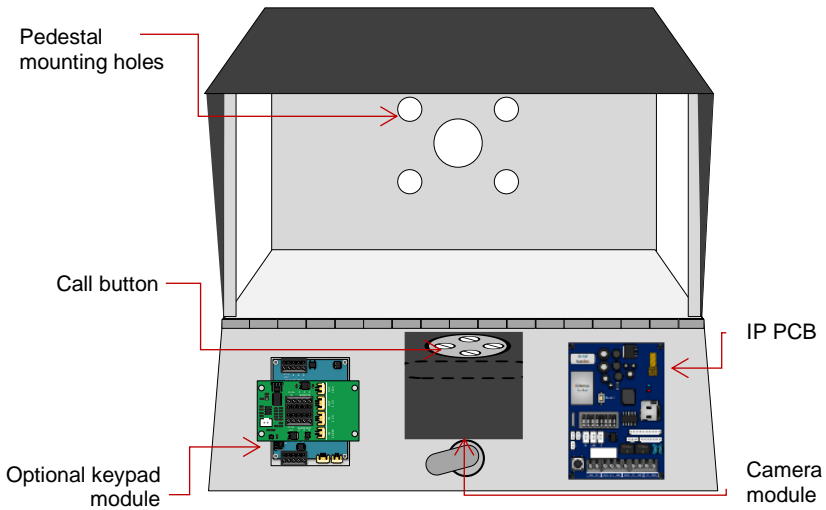

Main IP Module in Detail...

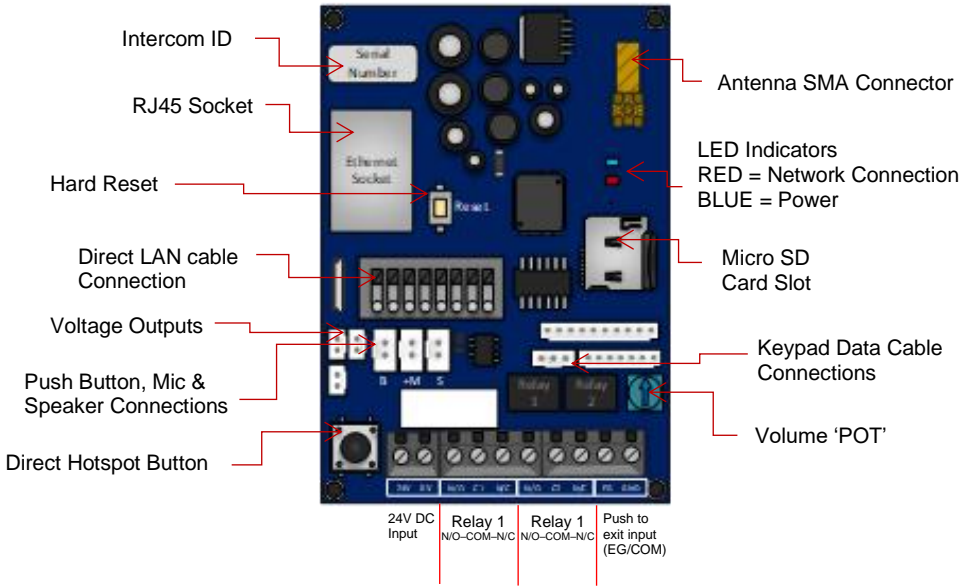

Keypad & PROX Module's in Detail

**optional extra*

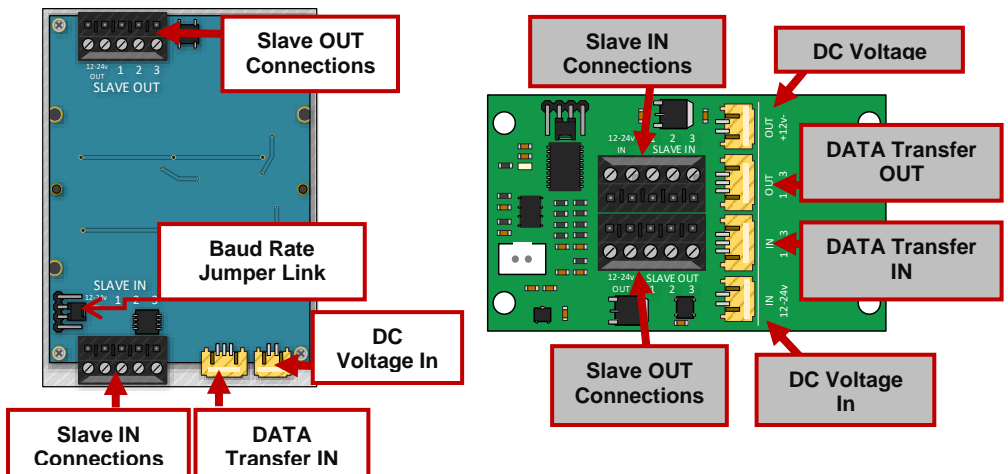

Technical Specifications

GENERAL	
Front Panel	<p>Portrait Orientation AB/ABK = 3mm Acrylic on Architectural Design Marine Grade Stainless Steel BS316 Front Plate</p> <p>AS/ASK = 3mm Marine Grade Stainless Steel BS316 on Architectural Design Marine Grade Stainless Steel BS316 Front Plate</p> <p>FS/FSK = Flush Design Marine Grade Stainless Steel BS316 Front Plate</p> <p>IMP/IMPK = 3mm Acrylic on Imperial Design Marine Grade Stainless Steel BS316 Front Plate</p> <p>Modular = Powder Coated Marine Grade Stainless Steel BS316 Front Plates with 3mm Acrylic on Design Marine Grade Stainless Steel BS316 Modular Plates</p> <p>Landscape Orientation PED = Pedestal Surface Mount</p>
Hood Cover (MOD, IMP(K), PED)	Powder coated Aluminium
Mounting Housing (Backbox)	Marine Grade Stainless Steel BS316
Call Button	Stainless-steel button with illuminated LED Ring
Weatherproof	IP55
Approvals	CE, FCC
Dimensions	See Datasheets
Operating Temp.	-25 to +55°C / -13 to 131°F
Power Supply	24V DC
Power Consumption	<p>IP PCB w/Keypad & Prox Standby = 96mA Operating = 500mA Peak = 2000mA</p>
Solar Power	<p>30Watt Solar Panel (minimum) 24V 10AH</p>

System Requirements	<p>Mobile device: Newest iOS on iPhone/iPad, newest Android on Smartphone/Tablet</p> <p>Internet: High-Speed Landline Broadband Internet connection, DSL, cable or fibre optic, no socks or proxy server. Min. suggested upload speed of 1.5Mbps,</p> <p>Network: Ethernet Network, with DHCP / WIFI 2.4GHz/5.8GHz (with applicable antenna)</p>
---------------------	--

Recommended Installation Height	Camera lens should be at a min. height of 145 cm (57 in). Before the installation please determine your optimal installation height.
---------------------------------	--

KEYPAD MODULE

Power Supply	24V DC
--------------	--------

Steel Keypad Module	<p>12 Square Metal Keys</p> <p>Blue illumination</p> <p>Keypad Codes configurable via App,</p> <p>Slave connection to allow up to an additional 8 slave devices</p>
---------------------	--

Silicon Keypad Module	<p>12 Round Silicon Keys</p> <p>Blue illumination</p> <p>Keypad Codes configurable via App,</p> <p>Slave connection to allow up to an additional 8 slave devices</p>
-----------------------	---

VIDEO

Camera	HD 720p, dynamic (VGA – HD)
--------	-----------------------------

Lens	<p>120° (D), 109° (H), 65° (V)</p> <p>IR-capable</p>
------	--

Display Resolution	<p>Switchable in the app by the Admin user.</p> <p>HD resolution: 1280*720</p> <p>SD resolution: 640*480</p>
--------------------	--

Video Codec	H264
-------------	------

Night-Vision	<p>Yes, light sensor, automatic IR-cut filter,</p> <p>5 Infrared LEDs</p>
--------------	---

Storage	<p>On-Board Micro SD Card (16GB included) Max read capacity 32GB</p> <p>Estimated capacity based on 16GB: 5,592 Video Clips (3MB) {AVI.} 33,500 images (0.5MB) {JPG}</p> <p>Supports Hot Swapping.</p> <p>Auto overwrites oldest data at 70% capacity</p> <p>FAT32 Formatting</p>
---------	---

MOTION SENSOR

Type	Active
Detection Type	Digital (Pixel-based) Changes of pixilation. This is processed by the CPU identifying any major/minor changes in pixels that is defined by a predetermined algorithm.
Range	>5m, depends on environment, distance is fixed
Configuration	Via App, e.g. <ul style="list-style-type: none"> • Sensitivity (1-5) • Enable/disable push notification • Enable/disable detection & recordings.

AUDIO

Audio Components	Speaker and microphone, noise reduction and echo cancellation (ANR, AEC)
Audio Streaming	Two-way, full duplex & half-duplex (switchable in-app)
Audio Codec	PCM/ARAW

NETWORK

WiFi	IEEE 802.11a/b/g/n/ac
WiFi Security	WPA / WPA2 / WPA3
Frequency Range	2.4GHz-2.4385GHz; 5.15GHz-5.845GHz
Ethernet	IEEE 802.3
Supported Protocols	HTTP, HTTPS, SSL/TLS, Bonjour, DNS, RTSP, RTP, TCP, UDP, RTCP, ICMP, DHCP, ARP

THIRD-PARTY INTEGRATIONS

Partners	N/A - Coming Soon
API	N/A - Coming Soon

PHASE 3

Setup

(To be done before installing the intercom)

Configure Before Install

Step 1

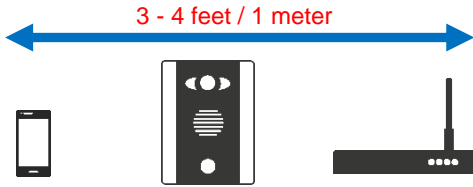

Do not install the intercom. Power it up beside the router so that you can perform the configuration with the homeowners' phone beside the intercom and router.

Note: If you skip this step and proceed directly to installation, technical support may request you go back and perform this step before diagnosing further.

Step 2 - Download and install the app on the end-user's phone.

Search for **Praetorian Guard** and find the icon, or scan the QR code if the phone has a QR scan app.

Note: Be sure to accept ALL permissions during install, otherwise you will experience problems later!

Tip: Slight differences will be seen between the Android and iOS app versions, any major differences will be highlighted in the screenshots below.



Please ensure you check the app for updates at least once a month.

Step 3 - Open the intercom and connect antenna for WIFI or LAN cable.

Loosen top screws

Use Key on lock

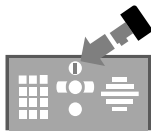

"Portrait" oriented models will have security screws at the top. Loosen only these with the security screwdriver provided.

Pedestal style "Landscape" orientated units will have a locking key.

Step 4 - Connect 24v DC power with the power supply provided.

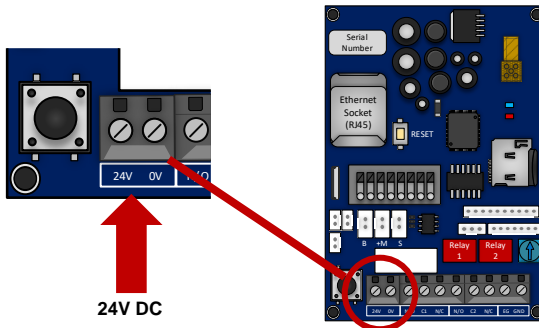

Power Consumption:
Standby = 96mA
Calling Out = 500mA

Connect to network using WiFi

Step 1 - Press and HOLD the code button for approx. 3-5secs and release. A tone will be heard.

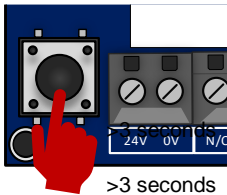

The intercom will now begin to transmit its own Wi-Fi network using the intercom ID reference.
(E.g., AES-XXXXXX-XXXX)

Tip: This will clear any currently stored WiFi connections from the system. You will need to reconnect to the WiFi network to allow the system to function again after pressing this button.

Step 2a – Find The WiFi Hotspot ID



With the user's phone, search for available Wi-Fi networks and connect to the 'Intercom ID' network.



TIP: Your phone needs to be within range of the intercom to detect this network.

Step 2b – Enter password to connect via WiFi

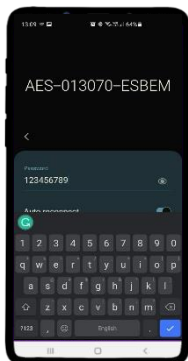

Enter the default pass code **123456789** and the users' phone should now be connected directly to the intercom.

Android: Press **CONNECT**

Apple: Press **DONE**

Note: Your device may state there is no internet connection. This is normal. Accept any prompts to stay connected for the next steps.

Step 3a, 3b, 3c – Find Intercom ID via the network connection



Settings > Add > Search

After pressing SEARCH, the APP will now search for the intercom and should detect it.

Step 3d, 3e

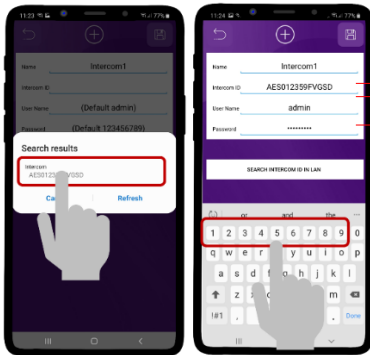

Intercom ID will be auto filled.

Enter "admin" for the main user.

Enter "123456789" as the default password and press SAVE

Step 4

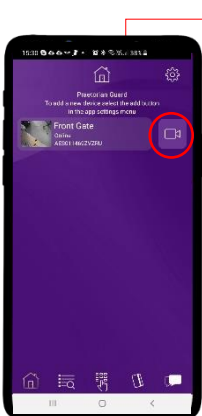

Should be showing ONLINE status.

Press the Video icon to view live video.

Note: at close proximity, you will experience acoustic feedback. This is normal.

If you can view live video, and hear acoustics, then this proves that the intercom hardware is working as it should.

Note: The intercom and phone are directly connected in a point-to-point link. It will still need connected to the network to be fully operational remotely.

Step 5a, b, c

Although we know the intercom is fully operational, we now need to connect it to the local Wi-Fi network.



The intercom is now searching the area for Wi-Fi networks and will display all compatible networks on the App screen.

Step 5d, e

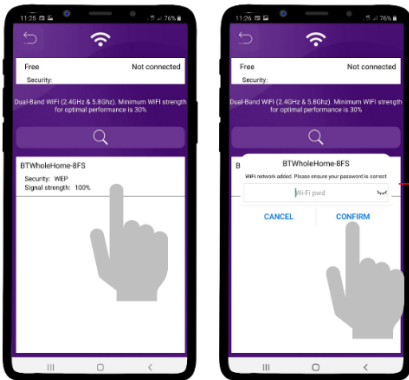

Enter the WIFI PASSCODE for the network which you are connecting to.



WARNING: Take care not to enter a typing mistake. The intercom will accept any Wi-Fi password and will not know if it is correct or not! Note that the intercom will show as 'OFFLINE' if an incorrect Wi-Fi Password has been entered as it will not be able to connect to the network at all.



Wi-Fi Signal strength must be at least 'Fair', or you will have problems!

Step 6



The intercom will now re-boot and attempt to connect to the Wi-Fi network with the password you have entered.

Wait 60 seconds then re-launch the APP.

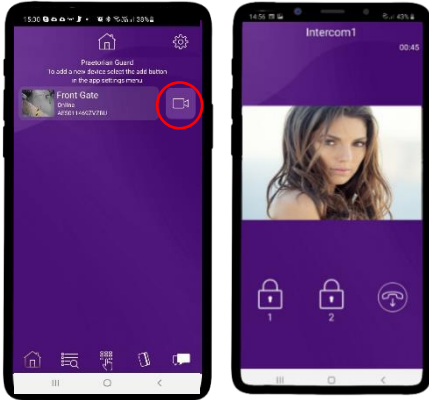

If you can see live video and hear audio, the intercom has successfully connected to the network.

If for some reason this does not work, try connecting to the Wi-Fi network again and double check the Wi-Fi password is correct.

Diagnostic Tips

1. Intercom is showing online status, but the video feed shows “fetching”.

A. This can be caused by poor power cable extended to the intercom, weak Wi-Fi, or too many devices connected to the Wi-Fi network and the router is incapable of managing the workload.

2. Intercom is not showing online status.

A. This can be caused by incorrect Wi-Fi password created, or Wi-Fi dropping out due to weak signal.

3. I can see video but there is no audio on the phone or there is no audio at the intercom.

A: Possibly permissions for the app were not accepted during app install. Check microphone permissions for the app in the phone settings.

4. The status is showing online, then connecting, then online again.

A: This is normal when a phone roams between two Wi-Fi connections, or between Wi-Fi and data.

WiFi Connection Setup Complete.

Skip to ‘Time Sync & Testing’

Connect to network using LAN Cable

This intercom can also be connected to a LAN cable directly from the router or from a repeater or point-to-point Wi-Fi bridge device.

Step 1

Note: Ethernet can travel up to 320ft on CAT5/CAT6 cable. Longer distances will require a switch every 320ft unless using any specialist equipment.

Option 1
Connect RJ45 Ethernet crimped socket.

Data transfer LEDs will flash when plugged in.

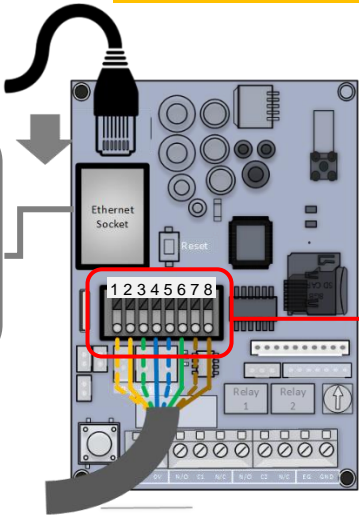

Option 2
Use provided spring-release terminals observing colour code shown.

Pin	Color
1	Orange / White
2	Orange
3	Green / White
4	Blue
5	Blue / White
6	Green
7	Red / White
8	Red

Step 2a, 2b, 2c – Find Intercom ID via the network connection.



Settings > Add > Search

After pressing SEARCH, the APP will now search for the intercom and should detect it.

Step 2d, 2e – Select the Intercom ID & input the login credentials.

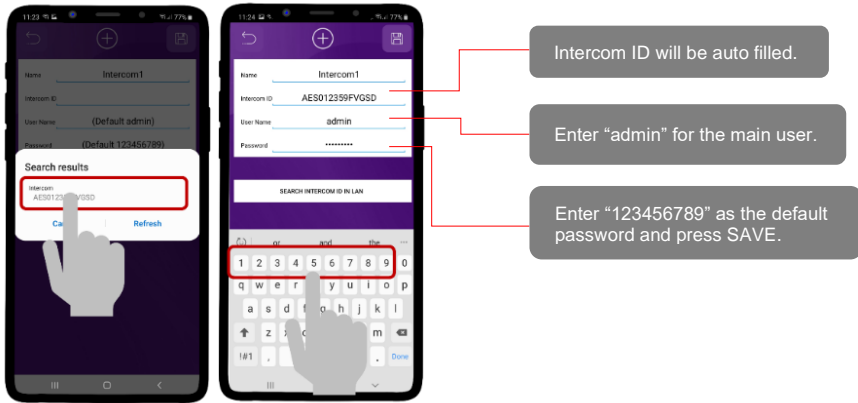

Step 3 - The intercom is now added to your device and should show Online.

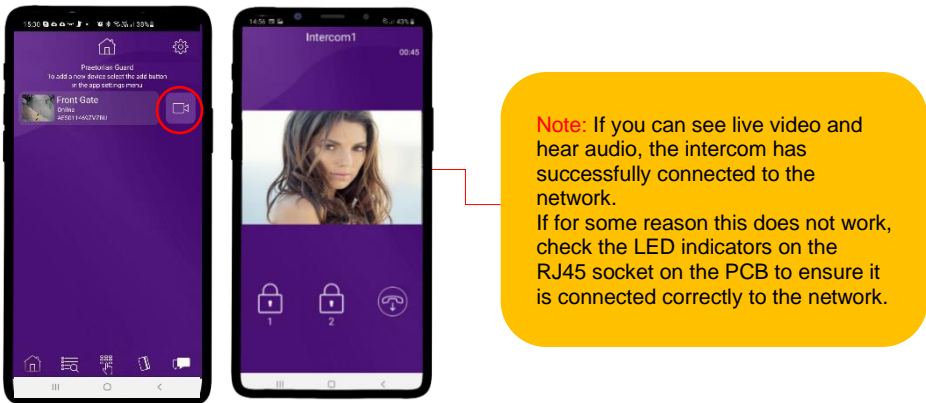

Diagnostic Tips

1. Intercom is showing online status, but the video feed shows “fetching”.

A. This can be caused by poor power cable extended to the intercom, weak Wi-Fi, or too many devices connected to the Wi-Fi network and the router is incapable of managing the workload.

2. Intercom is not showing online status.

A. This can be caused by incorrect Wi-Fi password created, or Wi-Fi dropping out due to weak signal.

3. I can see video but there is no audio on the phone or there is no audio at the intercom.

A: Possibly permissions for the app were not accepted during app install. Check microphone permissions for the app in the phone settings.

4. The status is showing online, then connecting, then online again.

A: This is normal when a phone roams between two Wi-Fi connections, or between Wi-Fi and data.

Time Sync & Testing

Step 1 - Ensure the intercom is now added to your device and should show Online.

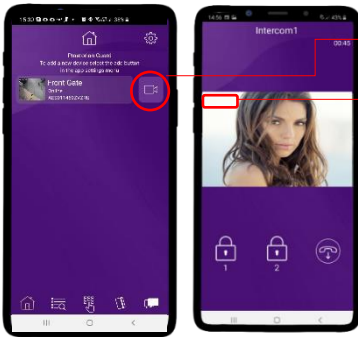

Press the camera icon to view the camera feed

Check the date/time stamp. The default date when the intercom has been reset is 1/1/1970.

If the date has not updated automatically follow the steps below to correct this.

Note: If the date stamp is incorrect it will prevent notifications being sent to the connected devices causing the user to miss calls.

If the time stamp is incorrect it will affect the accuracy of any recorded events in the events log and prevent any auto updates from successfully downloading.

Step 2 – Clock Sync

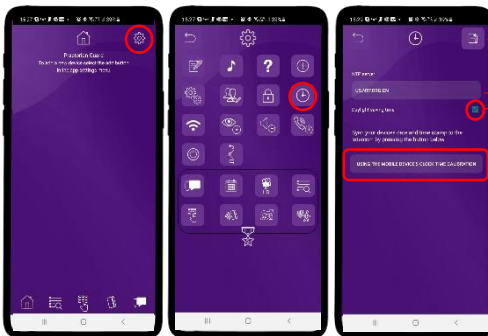

Save Settings

Select NTP Server

Enable or disable daylight saving time.

Sync your device time to the intercom

Note: You can choose any NTP server from the list. This is used to get a base for the current time. It will be adjusted to your time zone automatically when the calibration button is selected.

Step 3 – Confirm intercom timestamp is now correct.

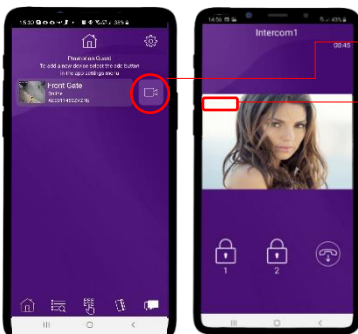

Press the camera icon to view the camera feed

Check the date/time stamp.

Step 4 – Close the app

PUSH notifications may not show while inside the app so to test that the PUSH notifications are working correctly you need to close the app.



Android: Select the 'back' button and then the 'EXIT' door icon will appear on the bottom left, tap this to completely close the application.

Step 5 - Press the call button.



The intercom will send a PUSH notification message via Google™ PUSH notification service through the internet to the phone.

The notification will need to be accepted and then the APP will launch to reveal the visitor and give the user an opportunity to either accept or reject the call.

The process to answer a call will depend on what device is being used. Please see next pages for the different process between Android and Apple.

Answering on Android

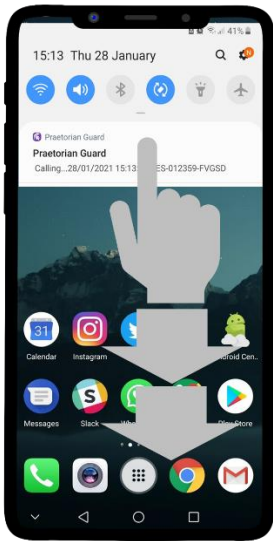

Swipe down to reveal the android notifications and press the Praetorian notification

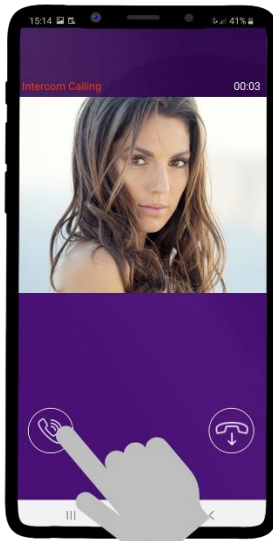

This will launch the app and reveal the answer screen. Press the icon shown to answer the call if you wish to speak to the visitor

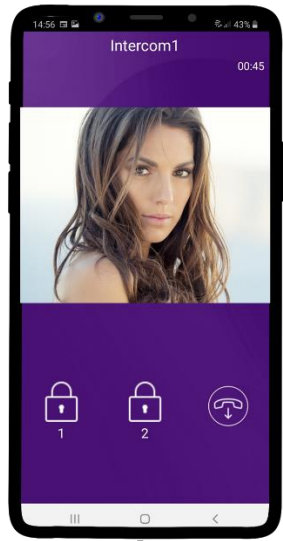

Press the appropriate lock icon (depending on which relay your installer has connected to the gate or door)

Answering on iOS (Apple)



Swipe the notification left



Press "VIEW"



Phone will now launch app. Press icon to answer

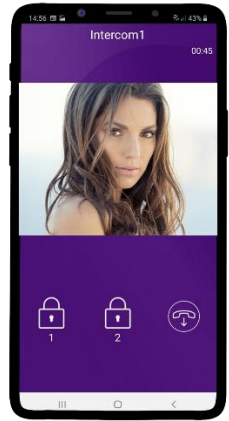

Note: Various versions of IOS and Android OS will have different notification acceptance techniques. Please refer to online support for your device if needed.

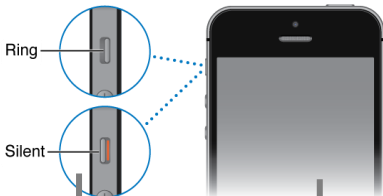

TIP: Make sure ringer switch is ON and volume is turned up.

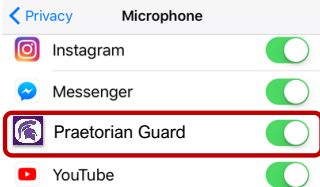

TIP: If there is no voice from the speaker at the gate, check the iPhone microphone permissions in Settings > Privacy / Microphone

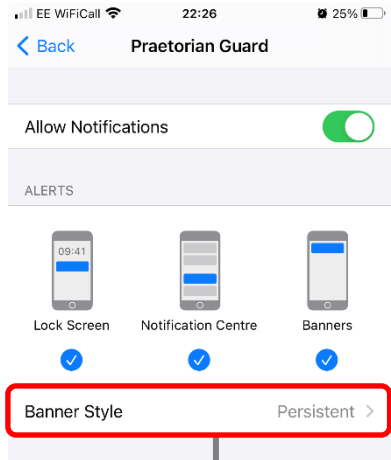

TIP: If you don't get notifications then check settings/notifications and select the app.

PHASE 4

Installation

(Only to be done after the unit is successfully proven to be operating on the network during setup on phase 3.)



**ATTENTION IMPORTANT
INFORMATION**



Recommendation!

Most technical calls received are due to installers using CAT5 or alarm cable to power the unit. Neither are rated to carry enough power (2 amp peak). Please use following cables:

0-2 (0-6 ft) use min 0.5mm² (18 gauge).

2-4 (6-12 ft) use min 0.75mm² (16 gauge).

4-8m (12-24 ft) use min 1mm² (14/16 gauge).

INSECT INGRESS WILL INVALIDATE WARRANTY

We recommend sealing all entry holes for prevention of insects that can cause issues with a risk of shorting out components.



How to Achieve & Maintain IP55 Rating

The IP55 rating attached to this unit is only achieved if the below steps have been followed. This is to prevent any unwanted water and/or bug ingress that can cause various issues with functionality and will void warranty if not followed.

Step 1 – Mount to location

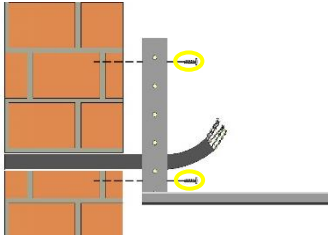

Use the pre-drilled mounting holes and cable cut outs to connect the intercom to the mounting option chosen.

Step 2 – Seal unit

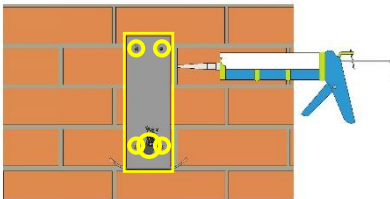

Seal all mounting or cable cut outs by using sealant such as silicone.

Ensure that any products being used are safe to use as some products can cause damage to the unit and/or the mounting location.

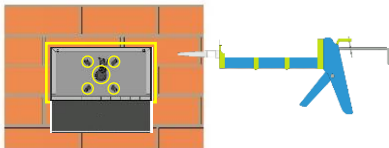

If surface mounting seal around the back box especially when used on an uneven surface.

Step 3 – Close unit

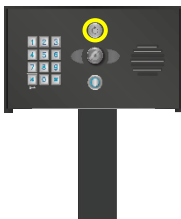

Pedestal Design



Architectural,
Imperial & Modular
Design

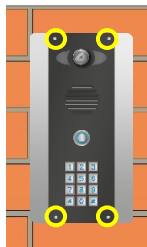

Flush Design

Ensure the security screws or cam lock is adequately closed to ensure a correct seal.

Installation (Wi-Fi)

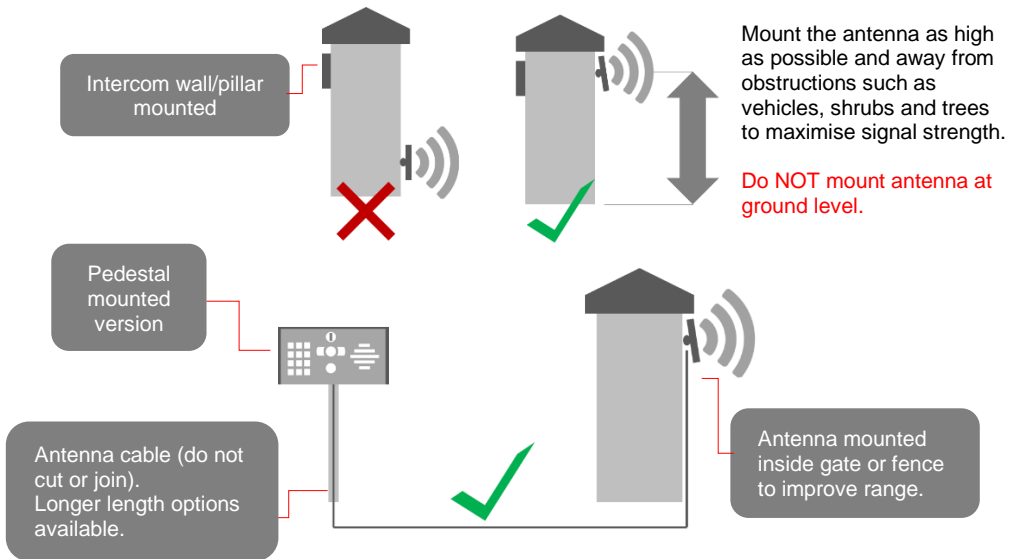

Installation (LAN Cable)

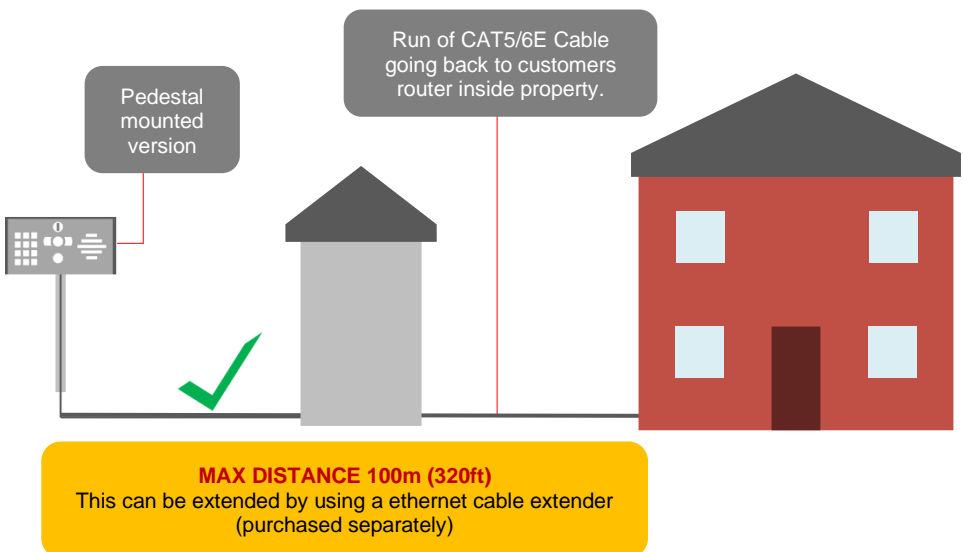

Power

This intercom comes with a 24v dc power supply. The intercom requires up to 2 amps peak demand at times, therefore power cable is of extreme importance.

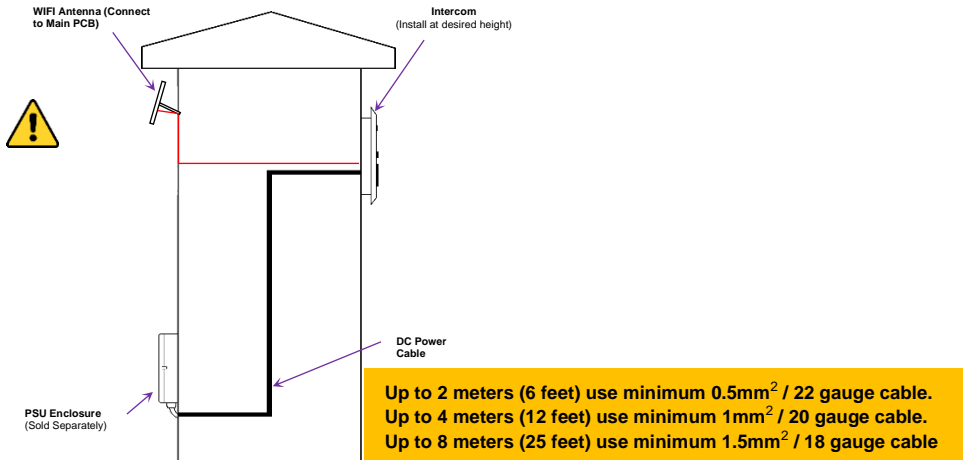

Solar Power

You can use solar power if required. You will require a DC voltage regulator applied at the gate board end as the voltage output can vary and cause too high a voltage, which will damage the intercom if over the 26v DC.

Our systems would require as a minimum a 30W of solar panel capacity and 10ah battery capacity for our intercoms.

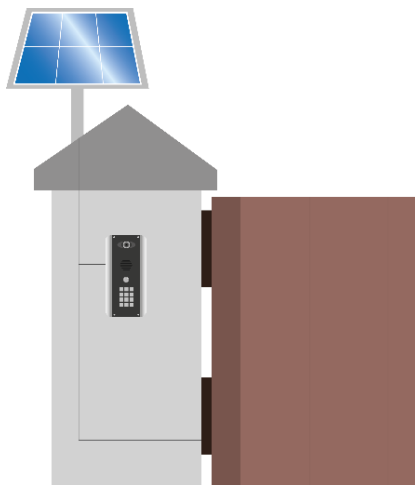

Power Consumption:
Standby = 96mA
Calling Out = 500mA

LAN Cable Setup Example

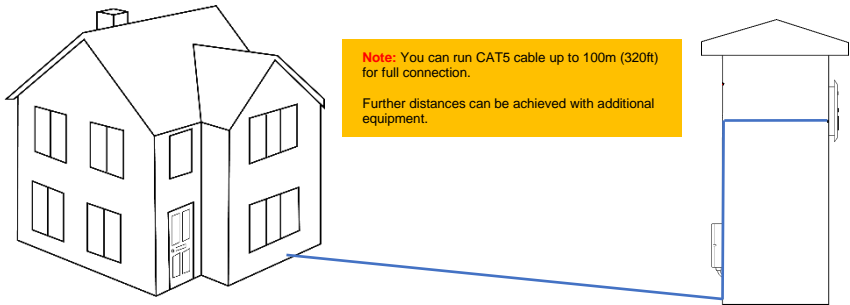

WiFi Setup Example

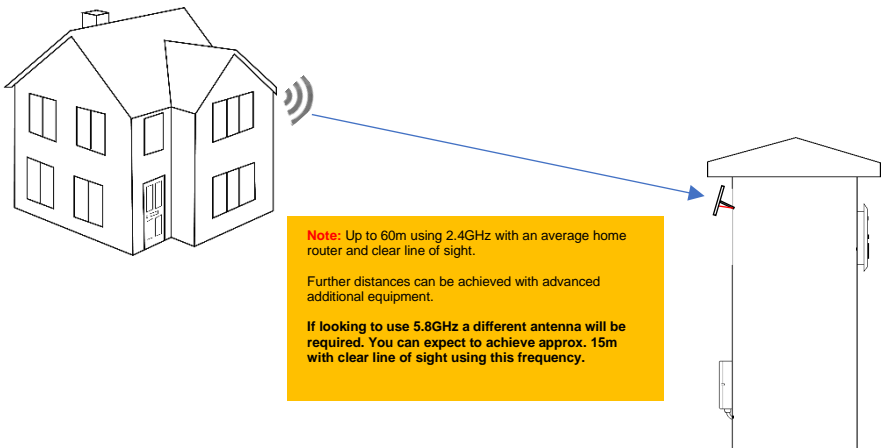

Wiring Example

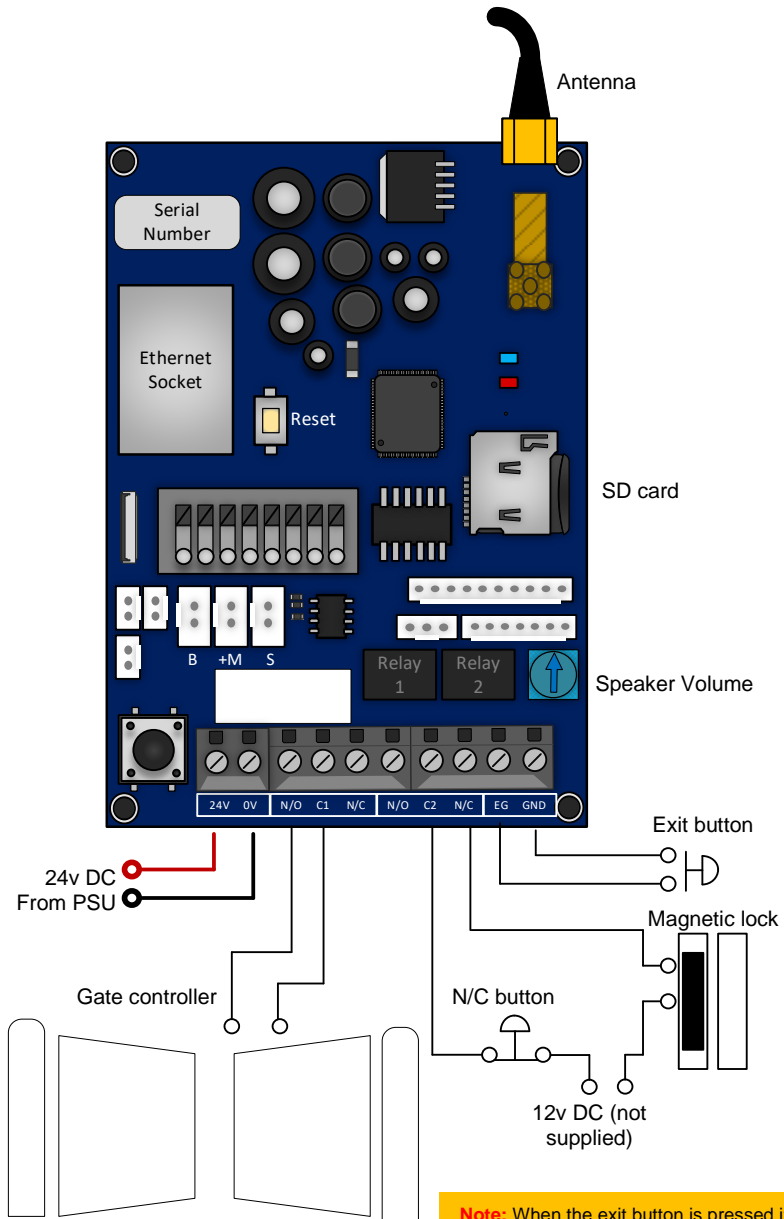

Note: When the exit button is pressed it will trigger relay 1 for the pre-programmed time in the app. (Default is 1 second)

Connecting Slave Devices

*Keypad module required

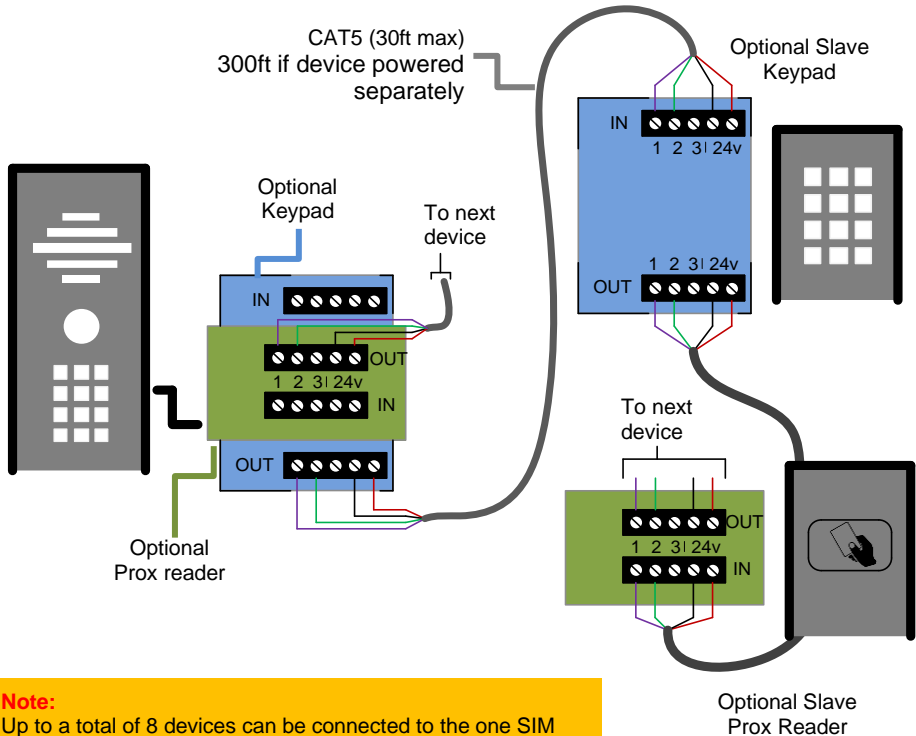

Note:

Up to a total of 8 devices can be connected to the one SIM module.

All keypads will be programmed with the same codes as the main unit.

All Prox units will store the same Prox cards.
Power slave devices separately for longer distances.

Adding Additional APP Users

Additional users **MUST** be added with individual usernames. Do **NOT** use the same username.

Step 1

On the **Admin user phone**, create a new username and password for any additional phones which you wish to add, as follows.



Step 2

On a **new phone** or tablet, perform the following steps to log on to the intercom with the details which have been created by the ADMIN phone above...



Note: Maximum 8 separate users and devices. Each device connected must be logged in with their own user account for correct operation. Only ADMIN can change critical system settings of the intercom.

Sound, Volumes and Speech

This intercom is capable of full duplex speech, which means two people can have a conversation and appear to speak at the same time. Since various manufacturers of android phones, iPhones and tablets all differ in acoustic performance, and different users may require varying levels of volume on their own handset, it may be possible to setup some devices in full duplex mode, but others may need to be set in half duplex mode (phone user will press to talk). This may also be required if a phone is in a particularly noisy environment, or the intercom is located near a busy main road with high levels of traffic noise.

Intercom Volume

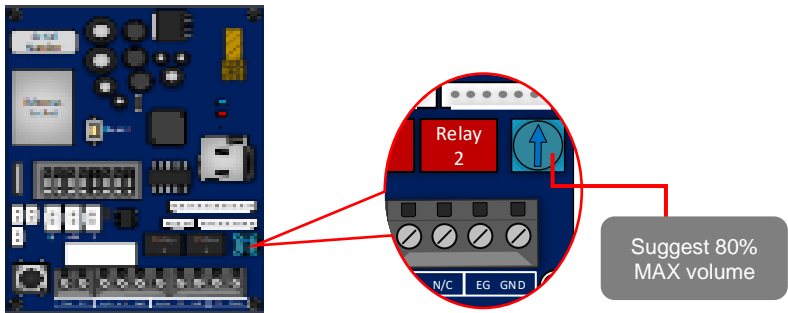

Intercom & Device Sound Options

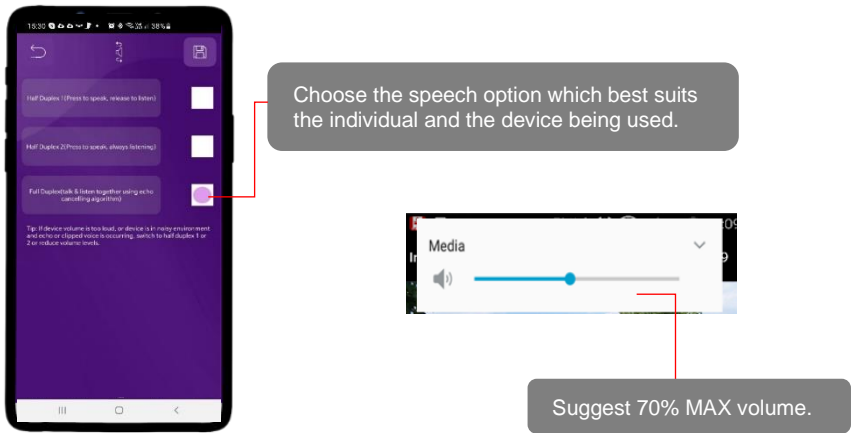

Using Keypad Codes

Ensure you program a keypad code in the app first then follow the steps below to use them on the keypad to gain entry.

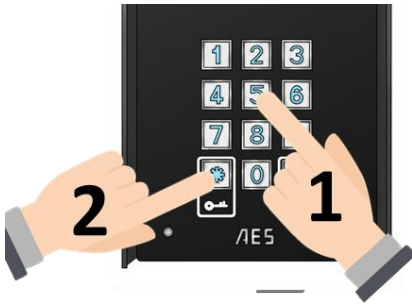

Enter pre-programmed 4-6 digit code., followed by the * key to confirm

Tip: Press * to confirm keypad code

PHASE 5

Advanced Setup

(Only to be done after the unit is successfully proven to be operating on the network after installation)

Feature Shortcuts

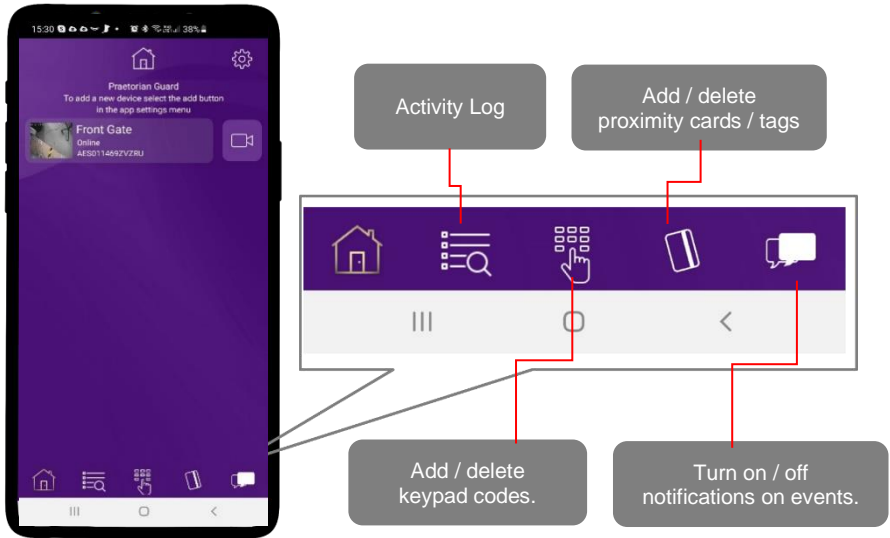

Settings Overview

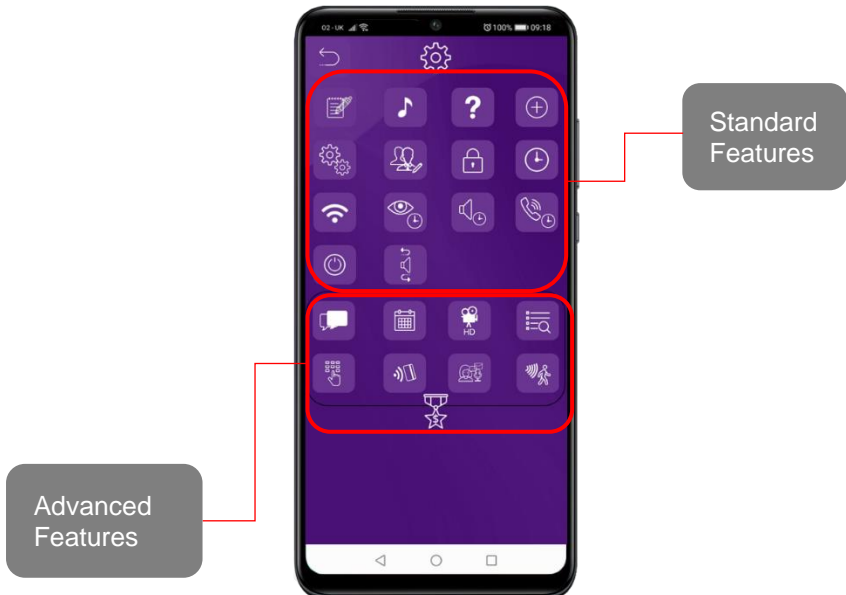

Standard Features

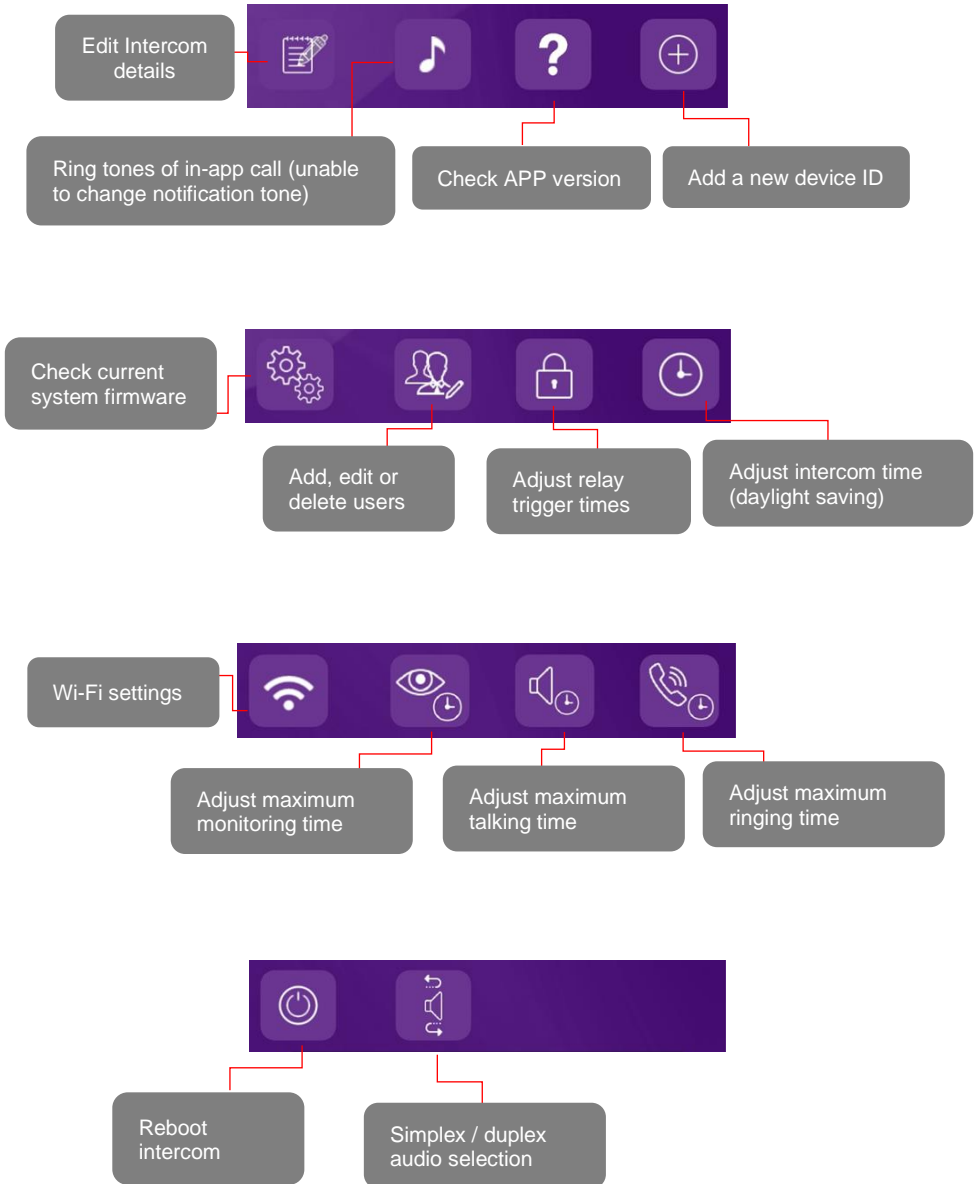

Edit Intercom Details

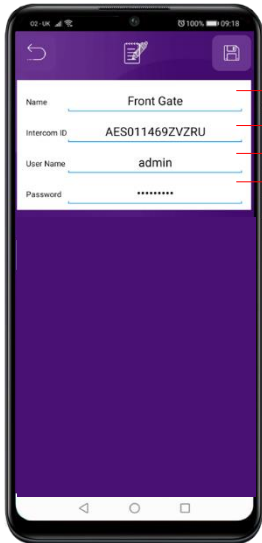

Change the name of the intercom

Intercom ID cannot be changed. Follow the add as a new device steps if ID is incorrect.

Change the username

Change the password

Add a New Device ID

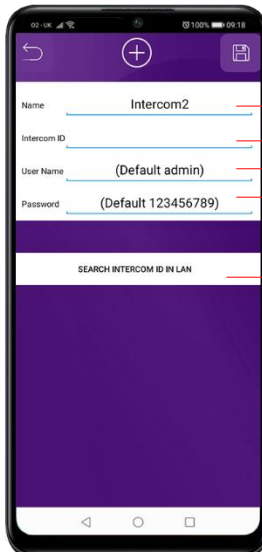

Name the intercom

Intercom ID can be added manually or auto filled by using the 'SEARCH INTERCOM ID IN LAN' button

Enter username, setup by the ADMIN

Enter password, setup by the ADMIN

If you are connected via LAN you can pull the ID via the network

Ringtones of In-app Call

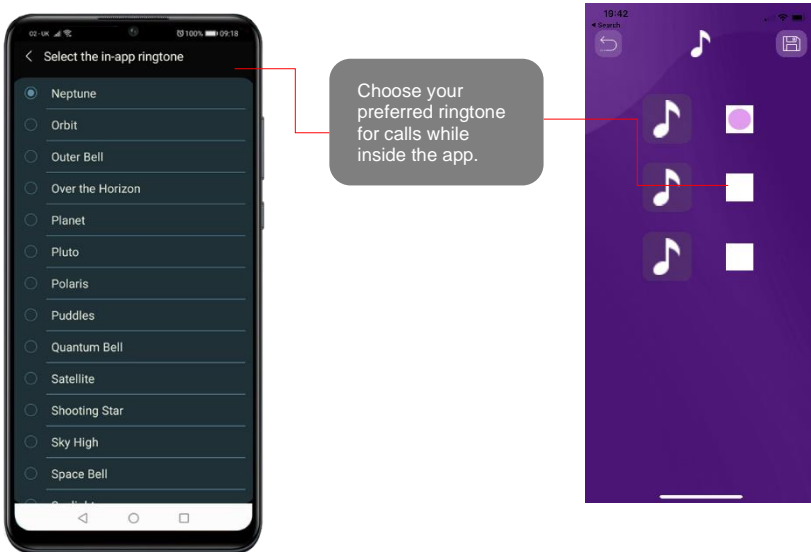

Note: The default call notification tone heard while not in the app cannot be changed.

Check APP version

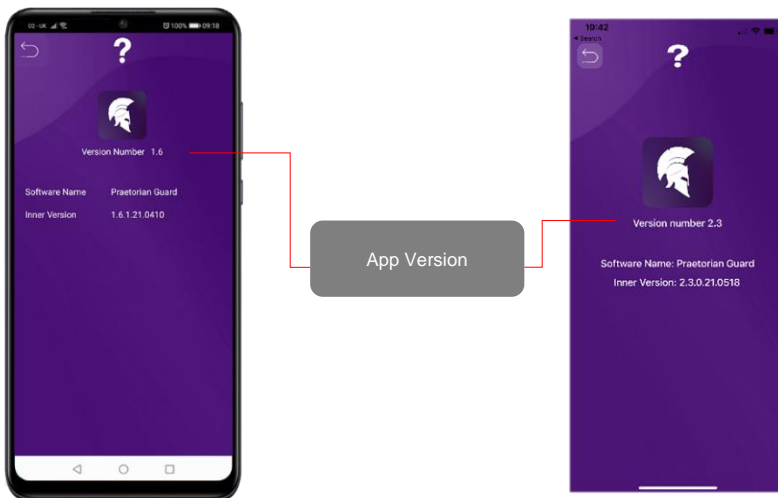

Note: Check the Google Play or the Apple app store to ensure you are using the most recent version.

Check Intercom Firmware



Intercom Firmware Version

Note: See 'Firmware Updates' for more info.

Add, Edit or Delete Users & Logins



Add New User

Edit User

Delete User



Username

Password

Cancel

Save

Note: Administrator account cannot be deleted but the password can be edited by selecting the pencil icon to the user.

Adjust Relay Trigger Times

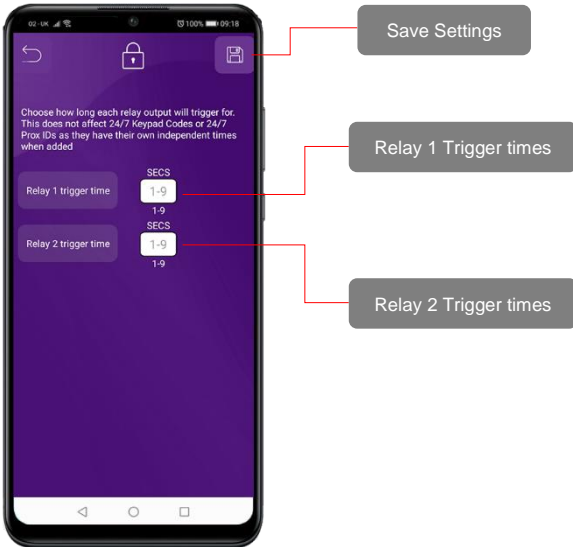

Adjust Intercom Time

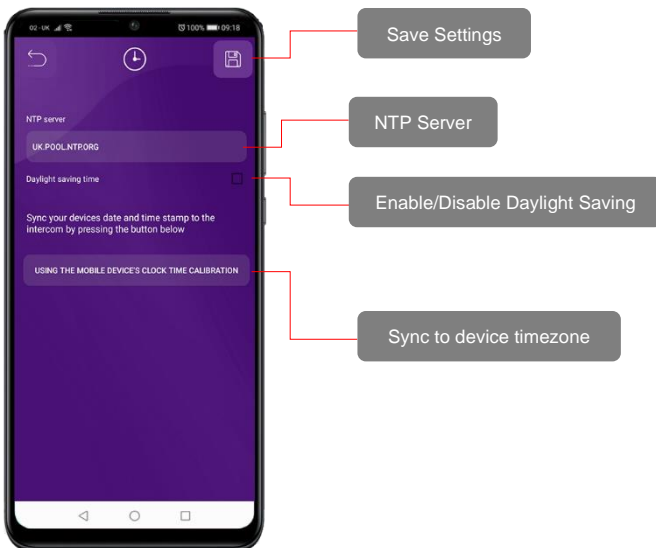

Wi-Fi Settings

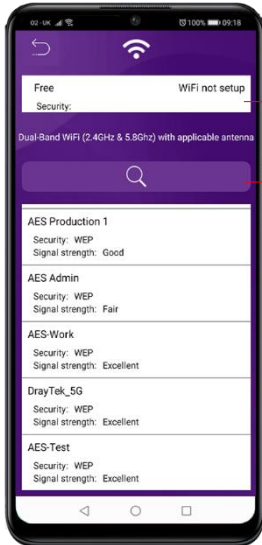

SSID currently connected to

Search for WiFi Networks.
See *WiFi Setup* for more details

Note: If showing POOR signal level, STOP!
You must reposition the antenna or look at alternative options to connect the intercom to the network.

Adjust Maximum Monitoring Time

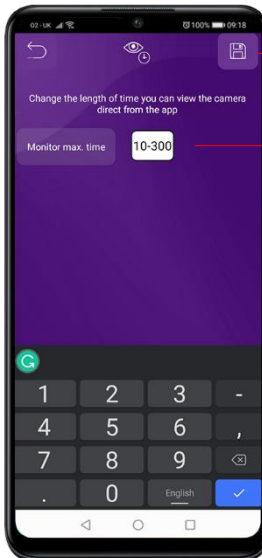

Save Settings

Change the length of time you can view the camera direct from the app

Adjust Maximum Talking Time



Save Settings

Change the length of time you can talk when a call is answered before the call disconnects.

Adjust Maximum Calling Time

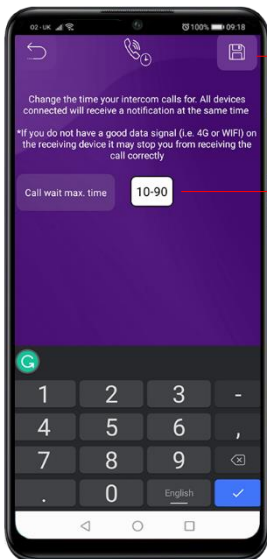

Save Settings

Change the length of time your intercom calls for.

Note: If you do not have a good data signal (i.e. 4G or WIFI) on the receiving device it may stop you from receiving the call correctly.

Note: All devices connected will receive a notification at the same time.

Reboot Intercom

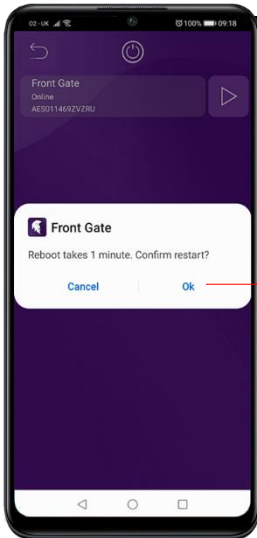

Soft Reboot the intercom

Simplex / Duplex Audio Selection



Save Settings

Soft Reboot the intercom

Soft Reboot the intercom

Soft Reboot the intercom

Note: If the volume on the device is too high or is in a noisy environment, it may cause echo or clipping in audio. If this occurs, you can turn down the device's volume or switch to one of the simplex audio options.

Advanced Feature Overview

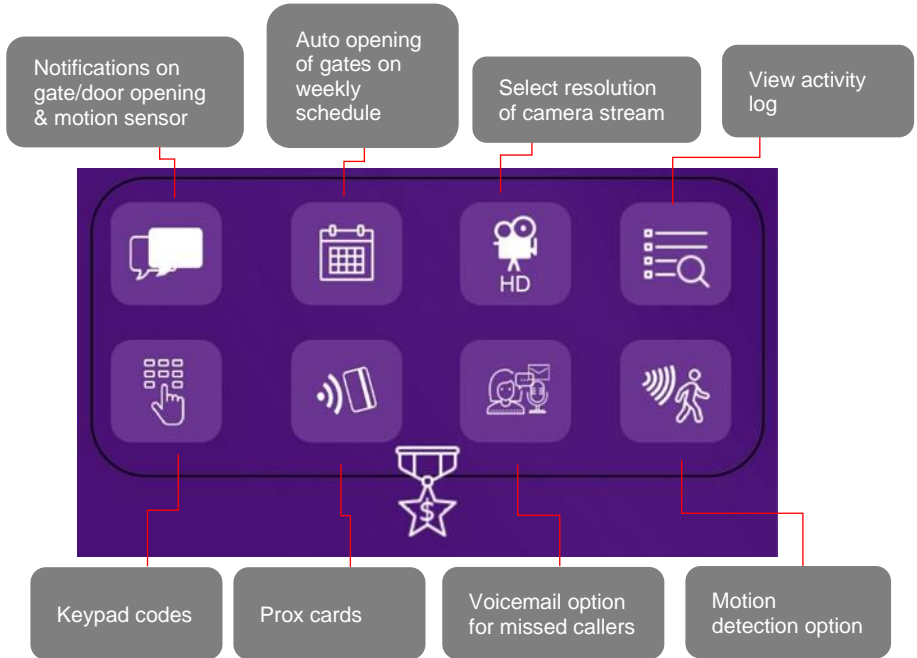

Notifications



Enable/Disable app push notifications.
(Default = OFF)

Relay Trigger – Anytime the relay is triggered a notification will be sent.

This will affect PROX ID's, Keypad Codes & In-App Relay triggers.
Relay 1 = Entrance 1
Relay 2 = Entrance 2

Motion Sensor – Anytime the motion sensor detects movement a notification will be sent.

Note: Motion Sensor feature needs **Enabled** too for this to work as expected. See Motion Sensor Settings.

Auto opening of gates on weekly schedule

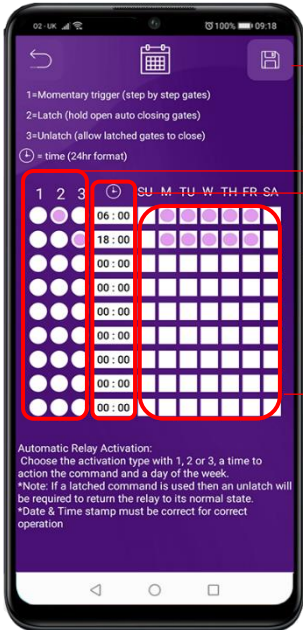

Save Settings

Relay Action

Time of Action

Day(s) for relay action to happen

Note: If a latched command is used then an unlatch will be required to return the relay to its normal state.

Date & Time settings of the intercom must be accurate for correct operation.

Select resolution of camera stream



Choose what resolution to use when your device is connected to WIFI & 4G.

Note: Data charges may apply if you exceed your personal allowance.

Activity Log

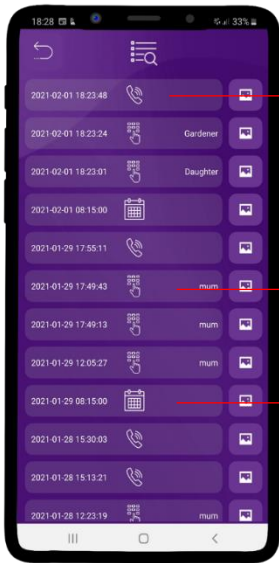

The log shows the most recent events which have occurred on the intercom. Some examples are shown. Some of the events capture images, or video from calls and can be played back by pressing the icons to the right.

Call received.

Keypad code entered.

Timed auto open event.

Note: SD card must be inserted into the slot on the PCB for this feature to operate correctly.

The log will show the last 100 events. Older events can still be retrieved via a microSD reader.

See page 10 for the SD card specifications.

Keypad Codes

*Keypad models only



There are 3 types of keypad code options which can be entered as shown.

1. 24/7 codes which work all of the time. **(max 100)**
2. Time restricted codes which only work on pre-set times and days. **(max 100)**
3. Auto Expire codes which are temporary. **(max 100)**

Note: Press the * button to confirm the keypad code after entering it.

1. 24/7 Codes (max 100)

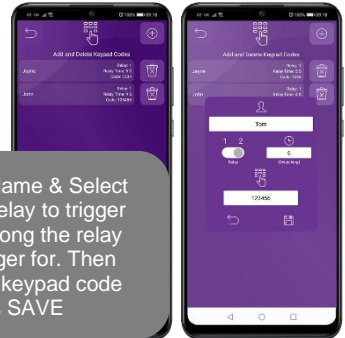

Enter Name & Select which relay to trigger & how long the relay will trigger for. Then enter a keypad code & press SAVE

2. Time Restricted Codes (max 100)

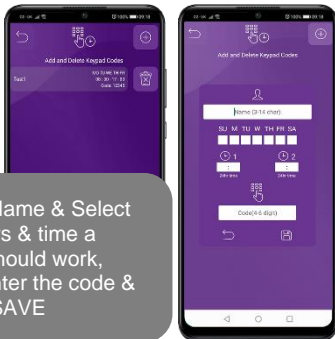

Enter Name & Select the days & time a code should work, then enter the code & press SAVE

Note: Time Restricted & Auto-Expire options are only available for Relay 1. The relay time is controlled via the main relay settings.

24/7 options have a relay time specific to each code.

3. Auto Expire Codes (max 100)

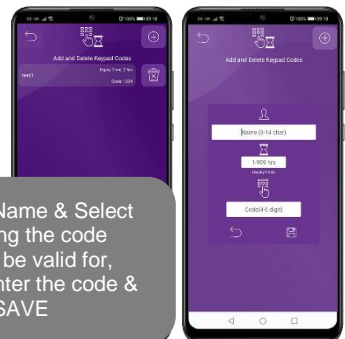

Enter Name & Select how long the code should be valid for, then enter the code & press SAVE

PROX Cards/Tag IDs

*PROX models only



There are 3 types of PROX ID options which can be entered as shown.

- 24/7 ID's which work all of the time. **(max 100)**
- Time restricted ID's which only work on pre-set times and days. **(max 100)**
- Auto Expire ID's which are temporary. **(max 100)**

1. 24/7 ID's (max 100)

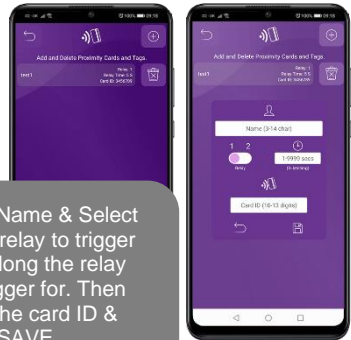

Enter Name & Select which relay to trigger & how long the relay will trigger for. Then enter the card ID & press SAVE

2. Time Restricted ID's (max 100)

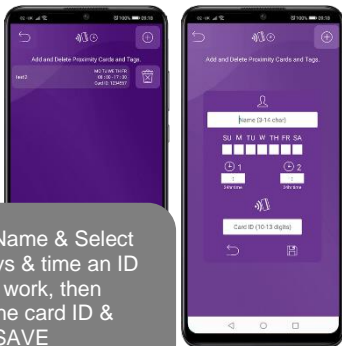

Enter Name & Select the days & time an ID should work, then enter the card ID & press SAVE

Note: Time Restricted & Auto-Expire options are only available for Relay 1. The relay time is controlled via the main relay settings.

24/7 options have a relay time specific to each code.

3. Auto Expire ID's (max 100)

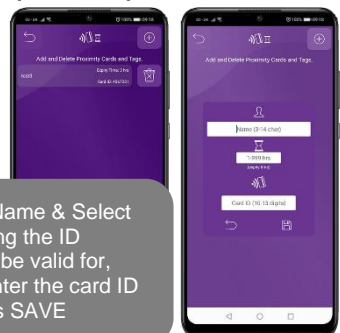

Enter Name & Select how long the ID should be valid for, then enter the card ID & press SAVE

Voicemail Option for missed Callers

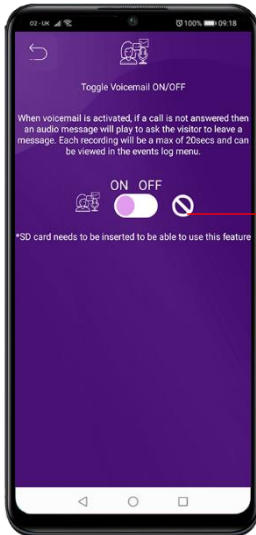

When voicemail is activated if a call is not answered then an audio message will play to ask the visitor to leave a message. A 20 second video recording can be viewed in the events log.

Enable/Disable Voicemail feature

Note: SD card must be inserted into the slot on the PCB for this feature to operate correctly.

The log will show the last 100 events. Older events can still be retrieved via a microSD reader.

Motion Detection Option

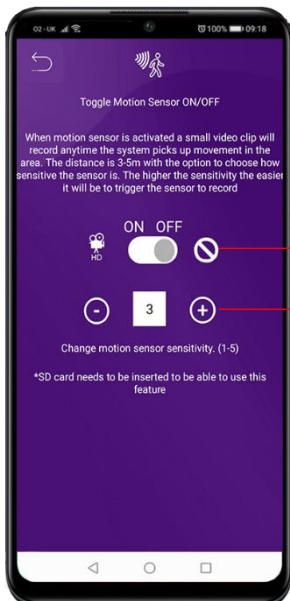

When motion sensor is activated a small video clip will record anytime the system picks up movement in the area.

The distance is fixed at max 5m with the option to choose how sensitive the sensor is. The higher the sensitivity the easier it will be to trigger the sensor to record.

Enable/Disable Voicemail feature

Change sensor sensitivity

Troubleshooting

It is worth remembering that when you install this intercom, you are literally only supplying 25% of the overall system. The other 75% already exists with the customer. Namely the router, the Wi-Fi network, and the phones or devices.

Anything can go wrong with any part of that entire system. Therefore, it is a useful exercise to attempt to prove to the customer that the intercom hardware is working and operational before attempting to diagnose the root cause, especially when connected wirelessly to a network.

If the intercom is connected via Wi-Fi to the network, it is very useful to press and hold the code button on the board, then connect the phone DIRECTLY to the BELL Wi-Fi network (must be within Wi-Fi range of intercom). Open the app and show the customer that when the phone is connected directly to the intercom, there is video and two-way speech. The job is then to find out what part of the installation or overall system is causing the problem since the intercom hardware has been proven as operational.

We can say without doubt that when we do get hardware failures, the above process will not work, and you will not get video and voice to the phone in a direct connection like this.

Below are the most common causes of problems with installs, starting with the most common first.

Symptoms caused	Problem/error	Solution
App showing offline status, video image shows "fetching, long lag on calls, intermittently showing online/offline, delayed push notifications.	Wi-Fi too weak at gate	Increase the height of the antenna if possible, install a Wi-Fi booster either inside the house near the front of the property, or a loft or eaves mounted external Wi-Fi booster, or install a CAT5 cable from the intercom to the router.
Delayed push notifications, video lag, voice problems, freezing, relays not opening the gate.	Wrong power cable (too thin) installed from 24v adaptor to the intercom, or power adaptor too far from intercom.	Change the power cable to specifications shown within this manual.
Lagging video or audio, delayed notifications, status showing intermittently online/offline, no or randomly operation of push notifications.	Too many devices on home network	Turn off as many other devices as possible, reboot the router and then try again. If the unit works, it proves to the customer that their router needs to be upgraded to handle the demand.
Intercom works well sometimes and not well other times. The Wi-Fi signal strength on the app Wi-Fi screen can sometimes be strong and other times is weak.	Several Wi-Fi networks using the same SSID	The intercom is jumping between networks depending on traffic and other devices connected to the same node. It is advisable to change the SSID name of the Wi-Fi network closest to the intercom to something individual.
Offline status. Will not connect to the network	Incorrect Wi-Fi password entered during setup	Try process again. Check the same Wi-Fi password works on your phone (forget the network and re-connect using the same password).
Can randomly display status "id already in use"	Additional user added incorrectly.	When an additional user was being added, the process was done incorrectly. Additional users MUST be added by the admin device first, with

		separate usernames created for each. The new usernames and passwords must be used by the new devices as shown in this manual to logon to the intercom.
App shows online when phone is in the same network but offline when phone on 3G/4G or on a remote Wi-Fi network, App works fine remotely to view gates but push notifications are not working at all.	Commercial firewall	This will be a job for the IT provider for the business. A port will need opened to allow P2P and PUSH notification traffic to pass through the firewall. Recommended unassigned ports which your network administrator can open are 6806, 6809 and 9123, 9124.
App shows online status locally and when phone is remote, but push notifications may be delayed, or video lag, or showing "fetching" on video screen.	Insufficient upload speed	This will need discussed with the ISP / broadband provider.
Intercom is online and working even through the application, but I am receiving no notifications even for calls! I have checked my Wi-Fi/Ethernet and the intercom meets minimum requirements	Incorrect time.	Cycle to the settings menu and navigate to the clock settings and press "sync phone time" to sync the current time from the cellphone. This should only ever need done once as the time is pulled from the server.
I think my intercom is not functioning correctly.	Firmware/software bug.	<p>Firstly ensure there is no network or site related issues. To do this you can connect directly to the system hotspot while in proximity of the unit and if the system operates fine then the local network and/or site specific issues are causing the problem.</p> <p>If the same issue occurs then a soft reboot can be completed by cycling to the settings menu and navigate to the power icon, pressing this will initiate a soft reboot. This soft reboot will remove any open communications or potential non-functioning features to be re-enabled.</p> <p>If this issue persists a hard reset may need to be performed. Access inside the panel is required and this will delete all current data programmed to the intercom and remove any additional users etc.</p> <p>If this still does not fix the problem this would suggest a hardware fault. Please contact technical support.</p>

App Updates

We will continually monitor the app's performance and will release updates to enhance the users experience and/or fix any issues that arise overtime. These updates will be available via the iOS app store or the Android Play store.

Firmware Updates

Firmware updates will be released to fix any bugs or to add additional features where possible throughout the products lifetime.

The most recent firmware version your system is using can be found by using the app

The most recent firmware version will be available via the manufacturer website along with details of any changes made. The updates will be sent to all devices when it is released and if your system is ONLINE at the time it will update with no interaction from the user.

If you find your intercom is on an older firmware and may have missed the automatic rollout you can contact the manufacturer technical support via phone or live chat who can perform the update manually via a remote desktop application.

Extra Resources

Find all our support resources on our website or scan the QR code below.



www.aesglobalonline.com

Intercom Maintenance

Bug ingress is a common issue in unit failures. Ensure that all components are sealed accordingly and check occasionally. **(Do not open the panel in the rain / snow unless correctly equipped to keep the internals dry. Ensure the unit is securely closed after maintenance)**

If you have an AB, AS, ABK, ASK callpoint it will have silver edges which are marine grade stainless steel so in normal weather conditions should not rust however it can dull or discolor over time. This can be polished with a suitable stainless-steel cleaner and cloth.

Environmental Information

The equipment that you bought has required the extraction and use of natural resources for its production. It may contain hazardous substances for the environment. In order to avoid the dissemination of those substances in our environment and to diminish the pressure on the natural resources, we encourage you to use the appropriate take-back systems. Those systems will reuse or recycle most of the materials of your end-of-life equipment.

The crossed-bin symbol marked in your device invites you to use those systems.



If you need more information on the collection, reuse and recycling systems, please contact your local or regional waste administration. You can also contact AES Global Ltd for more information on the environmental performances of our products.

Ingress



We recommend sealing all entry holes for prevention of insects that can cause issues with a risk of shorting out components.



To maintain the IP55 rating please follow the sealing instructions included. (also available online)

Warranty

Please note, by installing this product, you are accepting the following warranty terms:

1. The manufacturer's warranty is a "return to base" 2 year warranty from date of manufacture. This means that any suspected defective components or items are returned to the manufacturer's agent for investigation and diagnosis and returned at the cost of the customer.
2. The warranty does not cover, nor is the manufacturer or agent responsible for any of the following whatsoever: Storm damage, lightning or surge damage, flooding, accidental damage, vandalism or deliberate damage, un-explained corrosion or unusually harsh environments, failure of telephone networks, future un-interoperability between the product and network providers which cause mal-function due to changes implemented by the phone providers after manufacture of the product, or that which is outside of control of the manufacturer (e.g. 2G, 3G switch off, removal or inability to obtain VOLTE service), and damage due to not proper installation.
3. The manufacturer in no way accepts liability for any of the following incurred due to a product defect: Cost of attending site, inconveniences, labour rates, time lost, loss to or damage to property, security breaches, late payment clauses or breaches of any contracts between the installer and the client.
4. This is a profession install product only. The product is a component of an overall system. Therefore, it is the responsibility of the installer to certify the safety and compliance of the overall finished system. As soon as this product is fixed to another item, or connected to another third-party device, then the product has been modified, and compliance with local regulations in the country of install is strictly the responsibility of the installer.
5. Re-stocking fees may apply to items returned that are found to be non-defective. Complete units will also attract a re-stocking fee if returned for credit, regardless if a defect is discovered or not. Re-stocking fees may vary depending on the condition of the item being returned, and whether it can be determined as in brand new condition. The warranty terms do not entitle customers to an automatic full refund. For more details on returns procedures and re-stocking fees, contact the agent.
6. Items with physical signs of surge damage are not covered by warranty. Items with visible signs of surge damage will only be covered by warranty if photographic evidence is provided from site, showing surge protection has been installed.

Full warranty terms and conditions available upon request to AES Technical Department.

LEFT BLANK

LEFT BLANK

Regulatory Compliance

FCC Id: 2ALPX-WIFI-IBK

Grantee: Advanced Electronic Solutions Global Ltd

This device complies with Part 15 of FCC rules. Operation is subject to the following two conditions: (1) this device may not cause harmful interference, and (2) this device must accept any interference received, including interference that may cause undesired operation.

Output power listed is conducted. This device must be installed to provide a separation distance of at least 20 cm from all persons and must not be co-located or operating in conjunction with any other antenna or transmitter. End-users and installers must be provided with antenna installation instructions and transmitter operating conditions for satisfying RF exposure compliance. This device has 20MHz and 40 MHz bandwidth modes.



EU-RED Declaration of Conformity

Manufacturer: Advanced Electronic Solutions Global Ltd

Address: Unit 4C, Kilcronagh Business Park, Cookstown, Co Tyrone, BT809HJ, United Kingdom

We/I declare, that the following equipment (Video intercom), part numbers:

WiFi-iBK, WiFi-iB, WiFi-ABK, WiFi-AB, WiFi-BD, WiFi-BEK,
WiFi-BEik, WiFi-Bei, WiFi-BFT-KPAD

Complies with the following essential requirements:

EN 301 489-1 V2.2.0 (2017-03) (Electro-Magnetic compliance)

EN 301-489-17 V3.2.0 (2017-03) (Electro-Magnetic compliance)

EN 62479:2010 (Maximum output power)

EN60950-1:2006+A11:2009+A1:2010+A12:2011+A2:2013 (Electrical Safety)



This product is not a complete product until fully installed. It is therefore considered a component part of an overall system. The installer is responsible to check that the end installation complies with local regulatory requirements. This equipment forms part of a "fixed installation"

NEED MORE ASSISTANCE?

+44 (0)288 639 0693

