

63003451

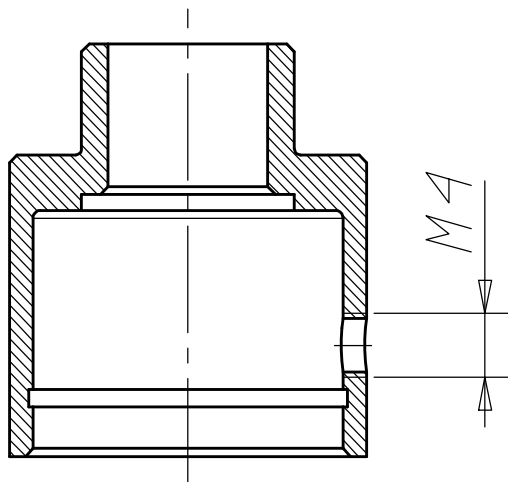

63000117