

XT2-XT4 FDS 433-868

XT2-XT4 FDS BD 433-868

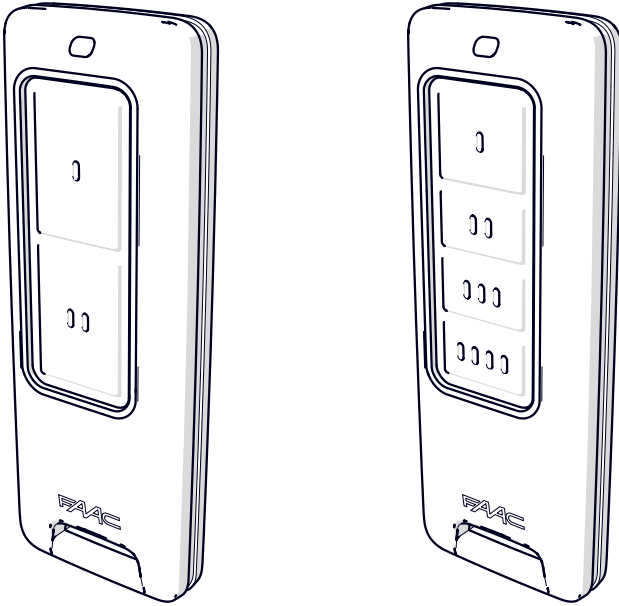

FAAC

CONTENTS

- 1. INTRODUCTION TO THIS INSTRUCTIONS MANUAL 3**
 - 1.1 MEANING OF SYMBOLS USED 3

- 2. PRODUCT INFORMATION 4**
 - 2.1 PRODUCT IDENTIFICATION..... 4
 - 2.2 TECHNICAL CHARACTERISTICS 5

- 3. FDS MODE..... 6**
 - 3.1 MEMORISING THE TRANSMITTER 6
 - 3.2 MEMORISING OTHER FDS TRANSMITTERS 8
 - 3.3 OPENING REQUEST 9
 - 3.4 STATUS REQUEST..... 10

- 4. SLH MODE..... 11**
 - 4.1 CONVERTING THE TRANSMITTER FROM FDS TO SECONDARY SLH 11
 - 4.2 CONVERTING THE TRANSMITTER BACK FROM SLH TO FDS 12
 - 4.3 MEMORISING AN SLH TRANSMITTER 13

- 5. FDS MODE - NON-REVERSIBLE PROCEDURES 14**
 - 5.1 RANDOMISATION PROCEDURE 14
 - 5.2 PROCEDURE FOR ENABLING THE LOCK FUNCTION 16

- 6. MAINTENANCE..... 18**
 - 6.1 REPLACING THE BATTERY 18

1. INTRODUCTION TO THE INSTRUCTION MANUAL

1.1 MEANING OF THE SYMBOLS USED



ATTENTION - Indicates an important note.



REPEAT - Repeat an operation or a sequence.



TIME - Perform the operation within the time indicated.



BASKET - Throw away.



CLOCK - Indicates the duration of the operation (in seconds)



FINGER - Press one or more buttons



DOTTED FINGER - Release one or more buttons



LED STEADY ON



LED OFF



GREEN LED



RED LED



SLOW FLASHING

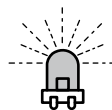

FAST FLASHING

2. PRODUCT INFORMATION

The XT2-XT4 FDS 433-868 and XT2-XT4 FDS BD 433-868 transmitters are available in two button (XT2) or four button (XT4) versions.

2.1 PRODUCT IDENTIFICATION

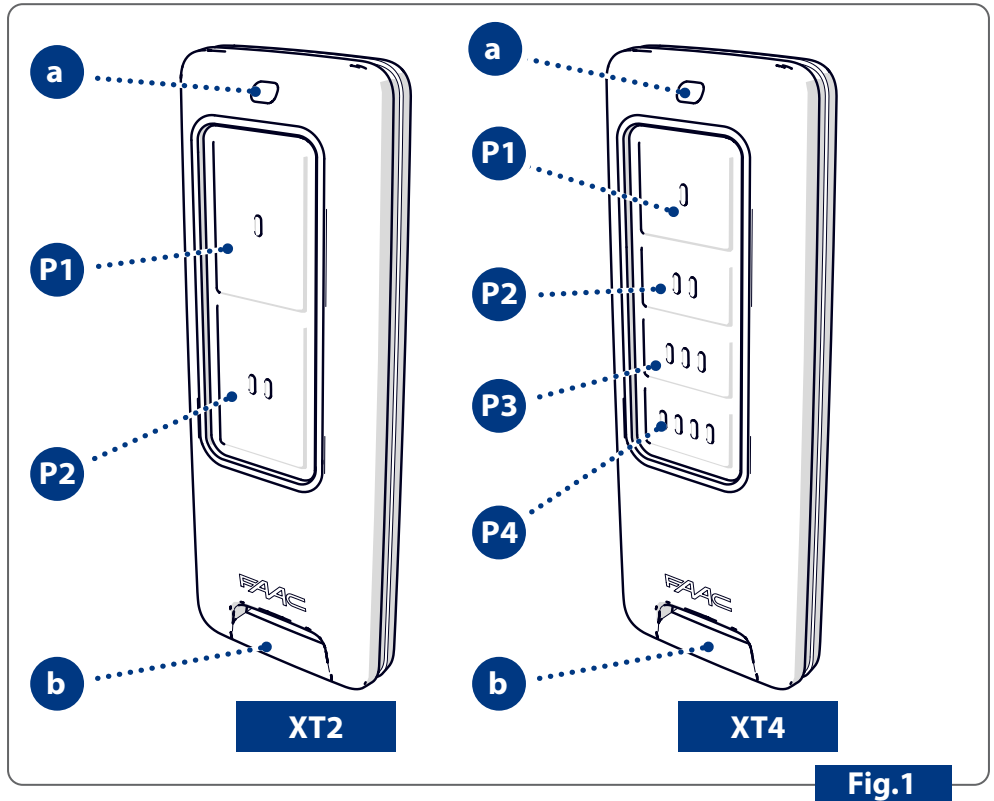

Fig.1

Pos	Description
a	LED
b	Slot for opening the transmitter
P1	Button P1
P2	Button P2
P3	Button P3
P4	Button P4

2.2 TECHNICAL CHARACTERISTICS

The new FDS (FAAC Digital Signature) radio system consists of the following products:

- Transmitters XT2/XT4 FDS 433-868 and XT2/XT4 FDS BD 433-868
- 3-Pin plug-in receiver XF FDS 433-868
- 5-Pin plug-in receivers with integrated decoding RP FDS 433-868, RP2 FDS 433-868
- External receivers with integrated decoding XR2N 433-868, XR4N 433-868

The transmitters and receivers communicate with each other at frequencies of 868MHz and 433MHz and use the best signal in terms of range and level of disturbance at all times.

FDS features an advanced security scheme aimed at achieving maximum protection against cloning. The radio transmission is protected by an AES-128 symmetric encryption algorithm with a 128bit key.

The transmitters indicated as BD have two-way communication with the receivers. This allows users to:

- Have feedback on the transmitter (two-colour LED + vibration) to indicate that the receiver has received the command that was transmitted.
- Use the receiver to indicate the gate status (closed/not closed)

BD transmitters are also fitted with an RFID tag compatible with XTRB FAAC readers.

The new FDS transmitters are compatible with the previous SLH model ("secondary" version only), and can therefore also be used with old systems which are already equipped with SLH transmitters.

FAAC Simply Connect allows the full management of FDS transmitters (simplified registration via Matrix-code on the back casing, single or packaged registration, time band management, enabling, disabling, deleting etc.).

TECHNICAL DATA	
Channels	2/4
Power supply	1 lithium battery 3V CR2032
Frequency	433.92/868.35 MHz
RF power	10 mW

3. FDS MODE

The procedures described below are valid for both the basic version FDS and the two-way version FDS BD (the two-way version vibrates to confirm that an operation has been performed).

3.1 MEMORISING THE TRANSMITTER

Refer to the receiver or the electronic equipment instructions to identify the buttons and LEDs described below.

Carry out the memorisation procedure keeping the transmitter about 50 cm away from the receiver.

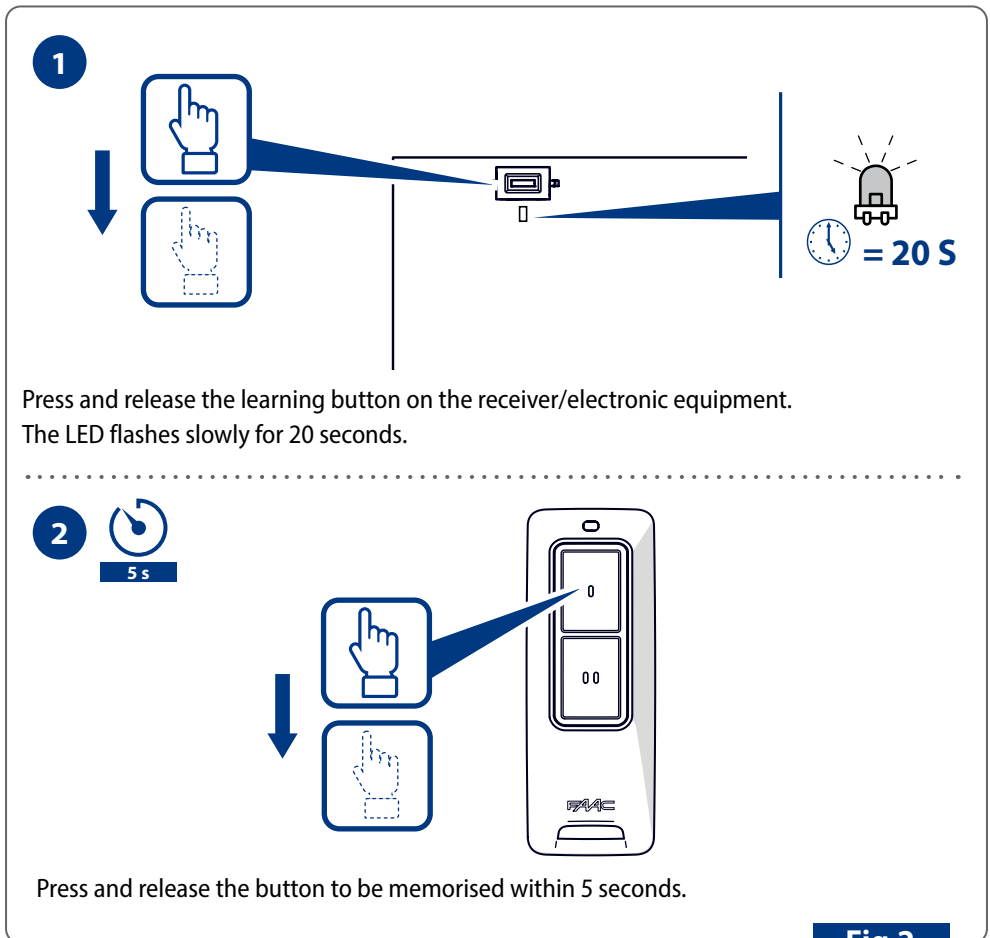
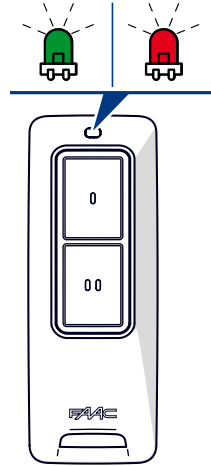
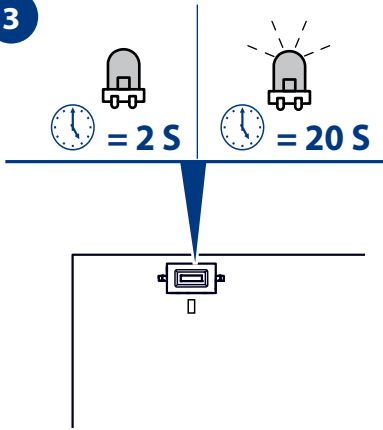

Fig.2

3



Whenever a code is memorised, the receiver/electronic equipment LED lights up steadily for 2 seconds and then flashes for 20 seconds, during which the user can memorise the new code.

If the memorisation was completed successfully, the LED flashes green and red.



If the LED is not steady and continues to flash for 20 seconds, it means that the memory is full.

4

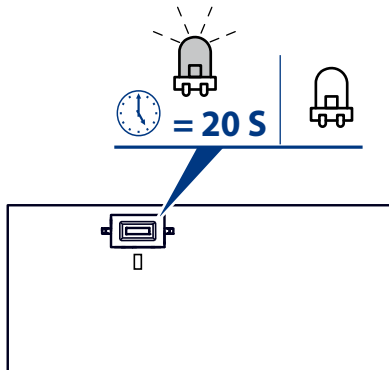

After flashing for 20 seconds from the last memorisation process, the LED switches off to indicate that the procedure has ended.

Fig.3

3.2 MEMORISING OTHER FDS TRANSMITTERS

1

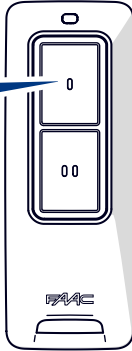

2

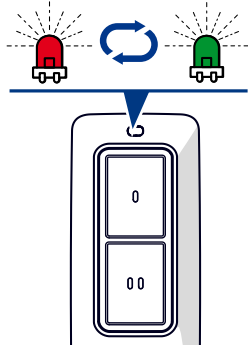

ALREADY MEMORISED

Press the button (P...) of the transmitter that has already been memorised for 10 sec. until the LED flashes quickly red/green in sequence and then release it. The LED flashes for 20 secs.

3

While the LED is still flashing, bring the new transmitter you want to register to a distance of less than 5 cm from it and keep one in front of the other.

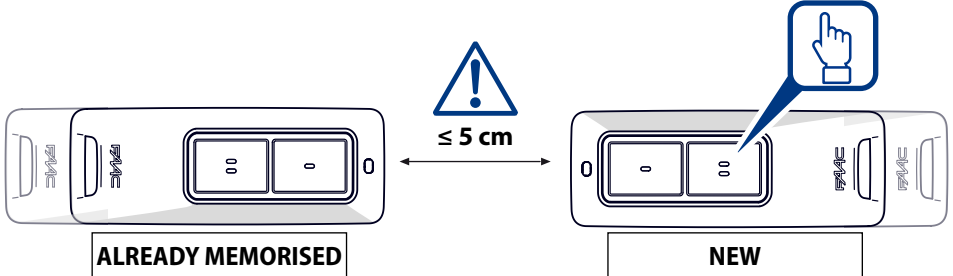

Press the button (P...) on the new transmitter, on which you wish to memorise the code.

4

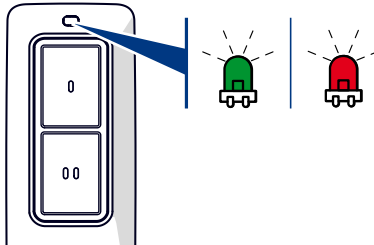

If it was memorised successfully, the LED of the new transmitter flashes green and red.

Fig.4

3.3 OPENING REQUEST



This procedure is only available on the two-way transmitters XT2-XT4 FDS BD

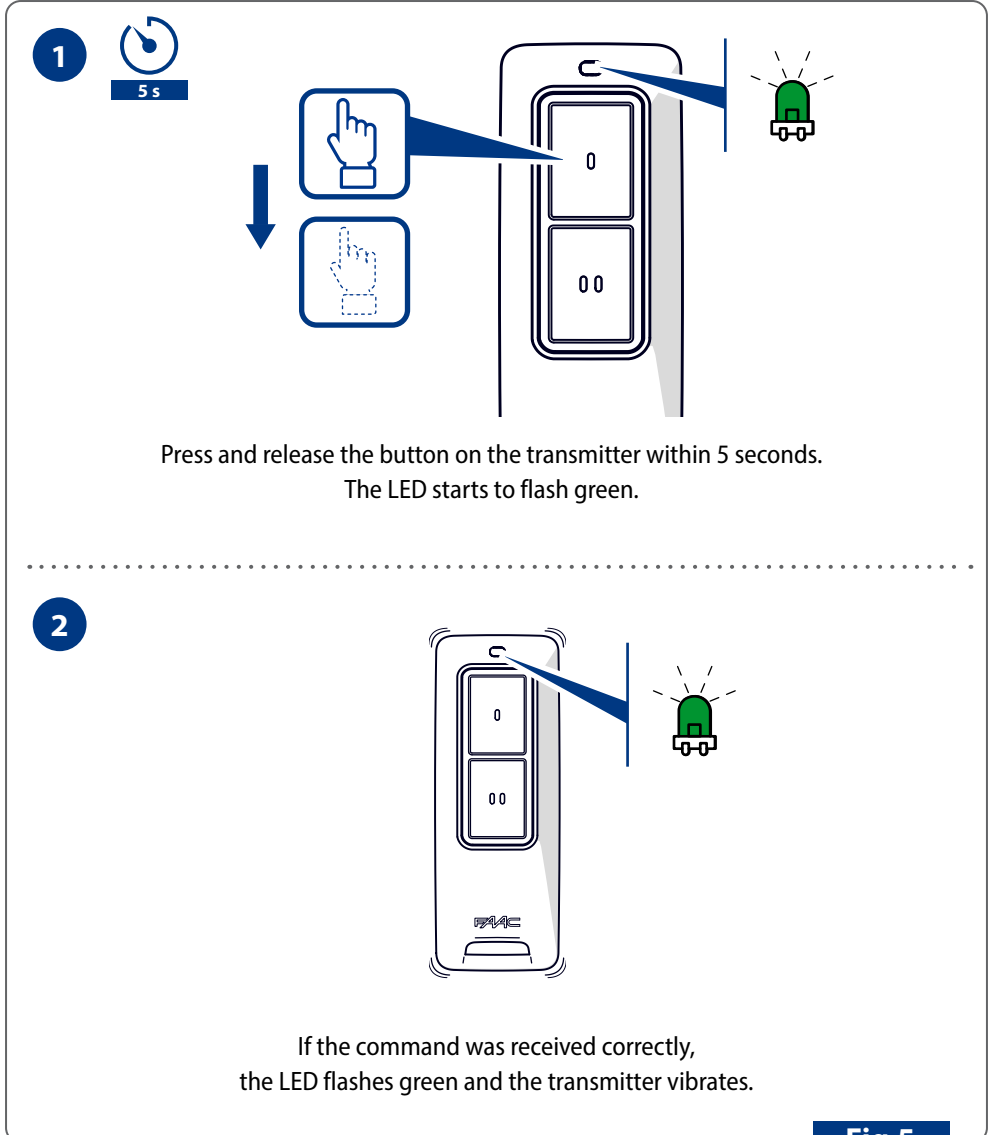

Fig.5

3.4 STATUS REQUEST



This procedure can only be carried out with XT2-XT4 FDS BD 433-868 transmitters and on boards with an integrated two-channel decoding system that are compatible with the XF FDS radio module.

1

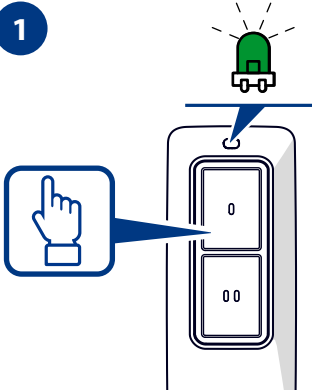

Press the button (P...) on the transmitter.
The LED starts to flash green.

2

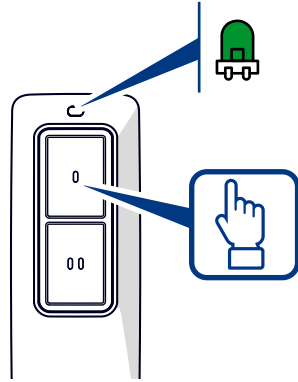

Keep it pressed until the LED turns steady green.

3

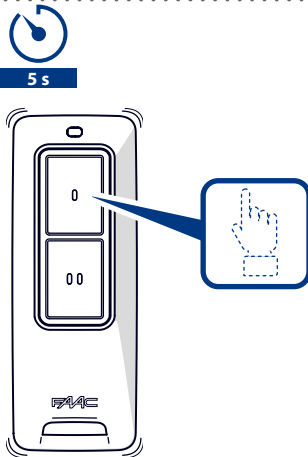

Release the button within 5 seconds.

4

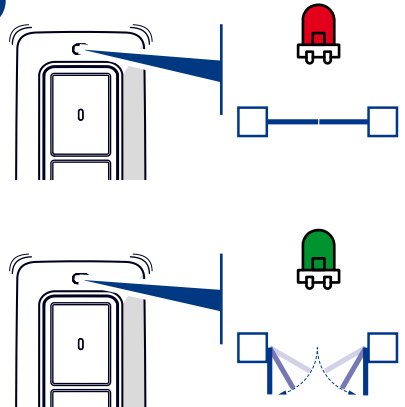

The transmitter vibrates and the LED turns steady red: automation closed.

The transmitter vibrates and the LED turns steady green: automation open or moving.

Fig.6

4. SLH MODE

4.1 CONVERTING THE TRANSMITTER FROM FDS TO SECONDARY SLH

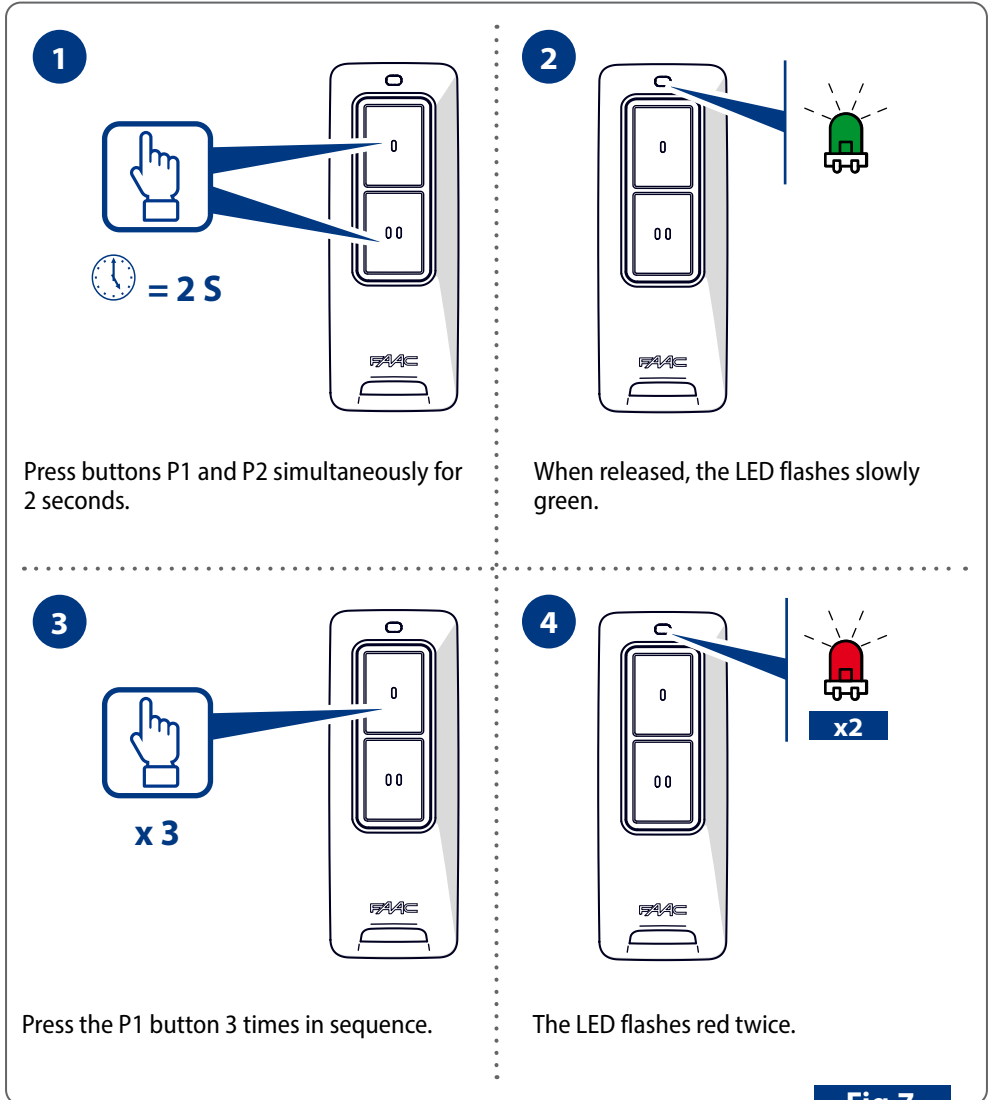

Fig.7

4.2 CONVERTING THE TRANSMITTER BACK FROM SLH TO FDS



A transmitter that was converted into a Secondary SLH can no longer be memorised on the receiver or by other transmitters.

Press any button on a transmitter converted into a secondary device, the LED immediately lights up steadily.

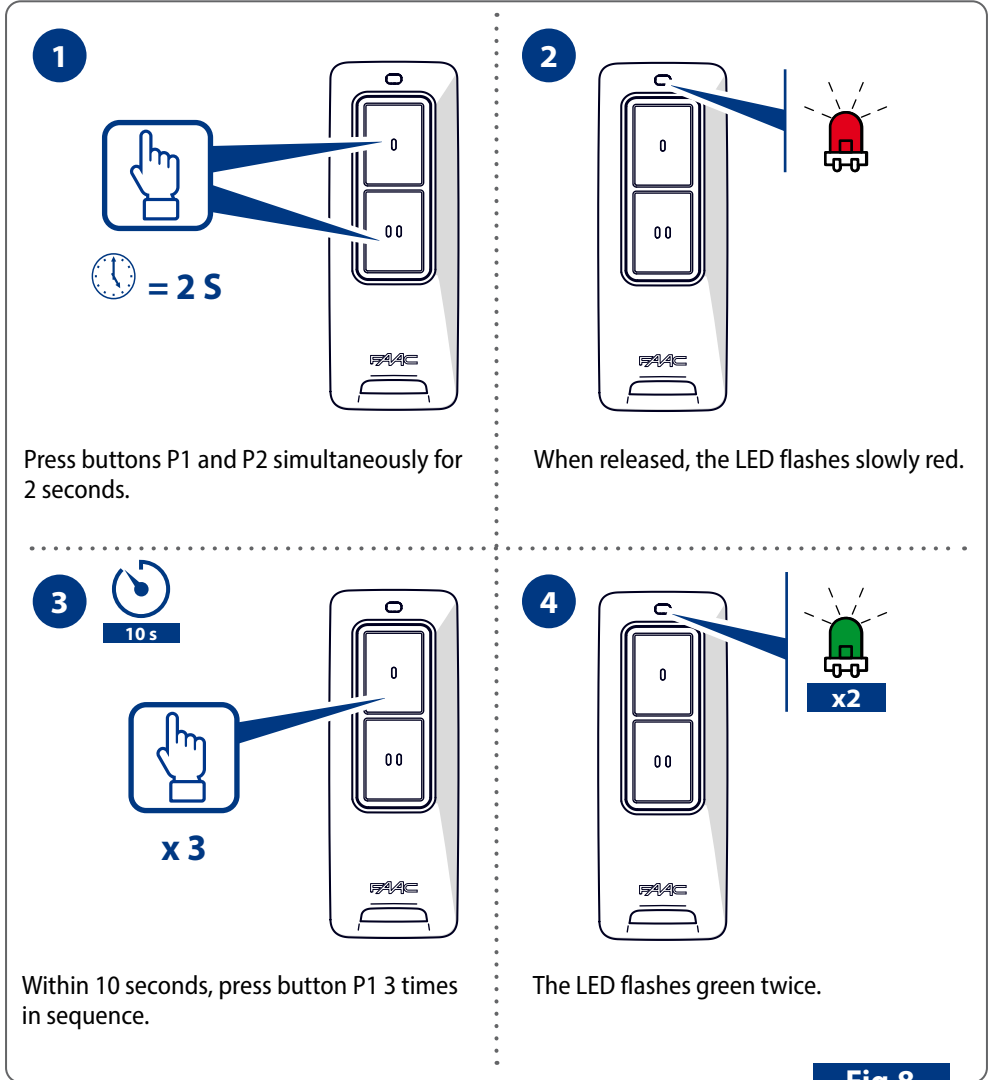

Fig.8

4.3 MEMORISING AN SLH TRANSMITTER



An FDS transmitter modified to Secondary SLH mode operates on the 433/868 MHz frequency band transmitted by the Primary SLH transmitter during memorisation.

1

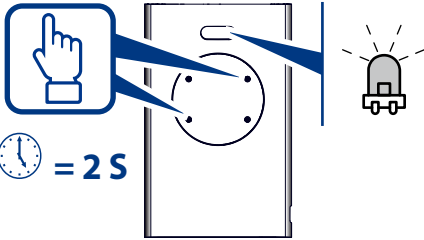

Primary SLH:

Press buttons P1 and P2 simultaneously for 2 seconds.

When released, the LED flashes slowly.

2

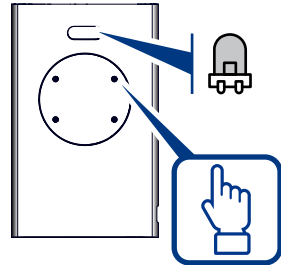

Press and hold the button to be transferred.

The LED lights up steadily.

3

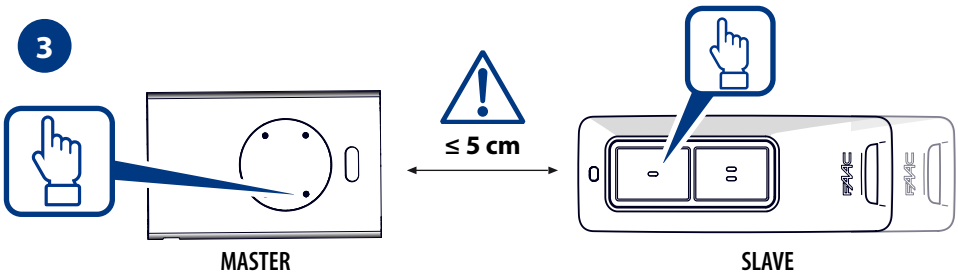

Press the button on which you wish to memorise the code.

4

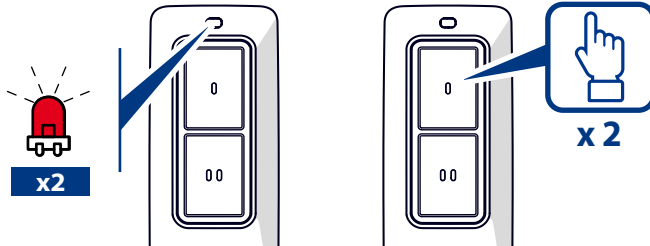

A double red flash will indicate that it was memorised correctly.

When used for the first time, press the memorised button twice in succession.

Fig.9

5. FDS MODE - NON-REVERSIBLE PROCEDURES

5.1 RANDOMISATION PROCEDURE

This procedure generates new radio codes on all buttons of the transmitter.

After randomisation, the transmitter will no longer work in the systems in which it had been memorised.

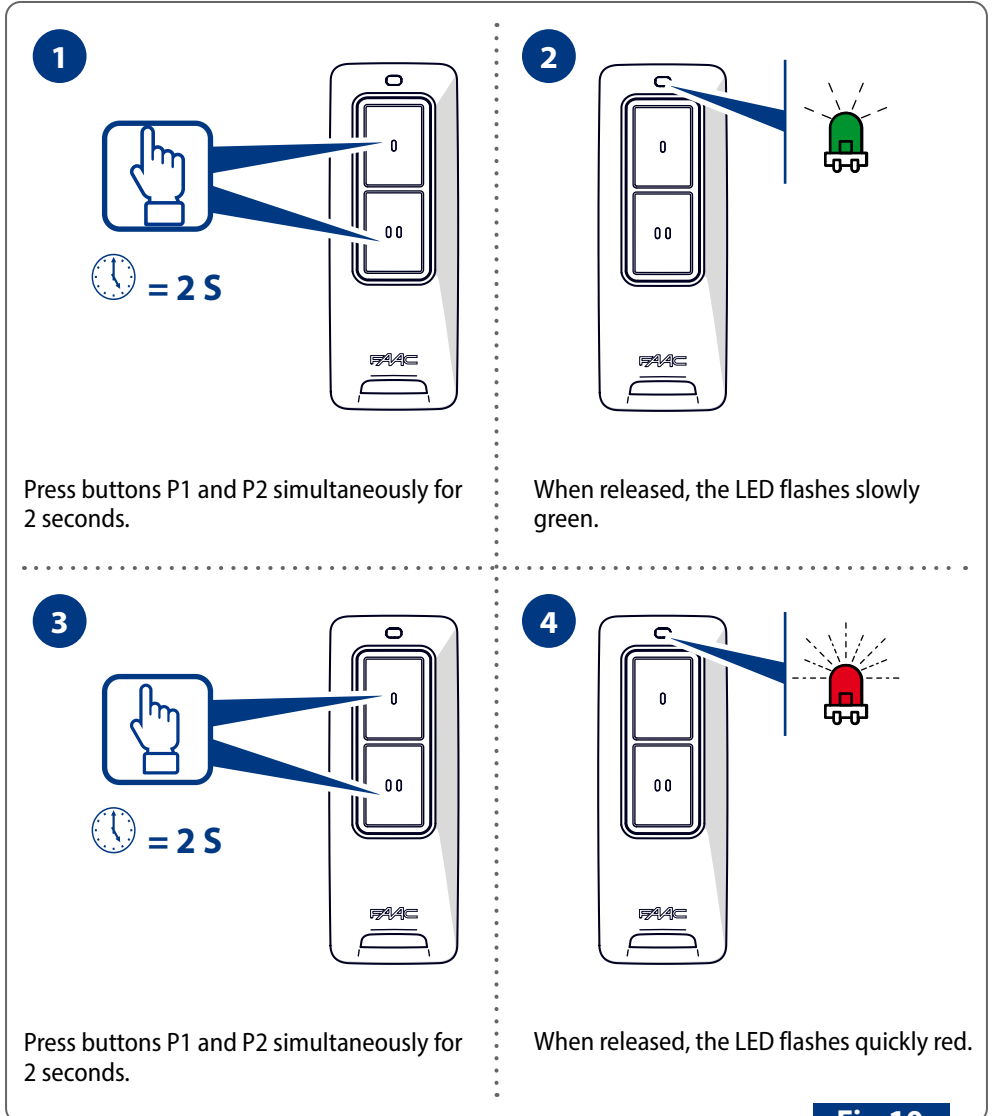
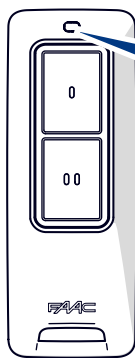

Fig.10

5



6



Press the buttons in the following sequence:

1. P2
2. P2
3. P2

If the procedure has been carried out correctly, the LED turns on steady red for 5 seconds.

Fig.11

5.2 PROCEDURE FOR ENABLING THE LOCK FUNCTION

A transmitter with the lock function enabled can no longer carry out the memorisation procedure on the receiver or other transmitters.

The code has to be randomised in order to unlock the transmitter.

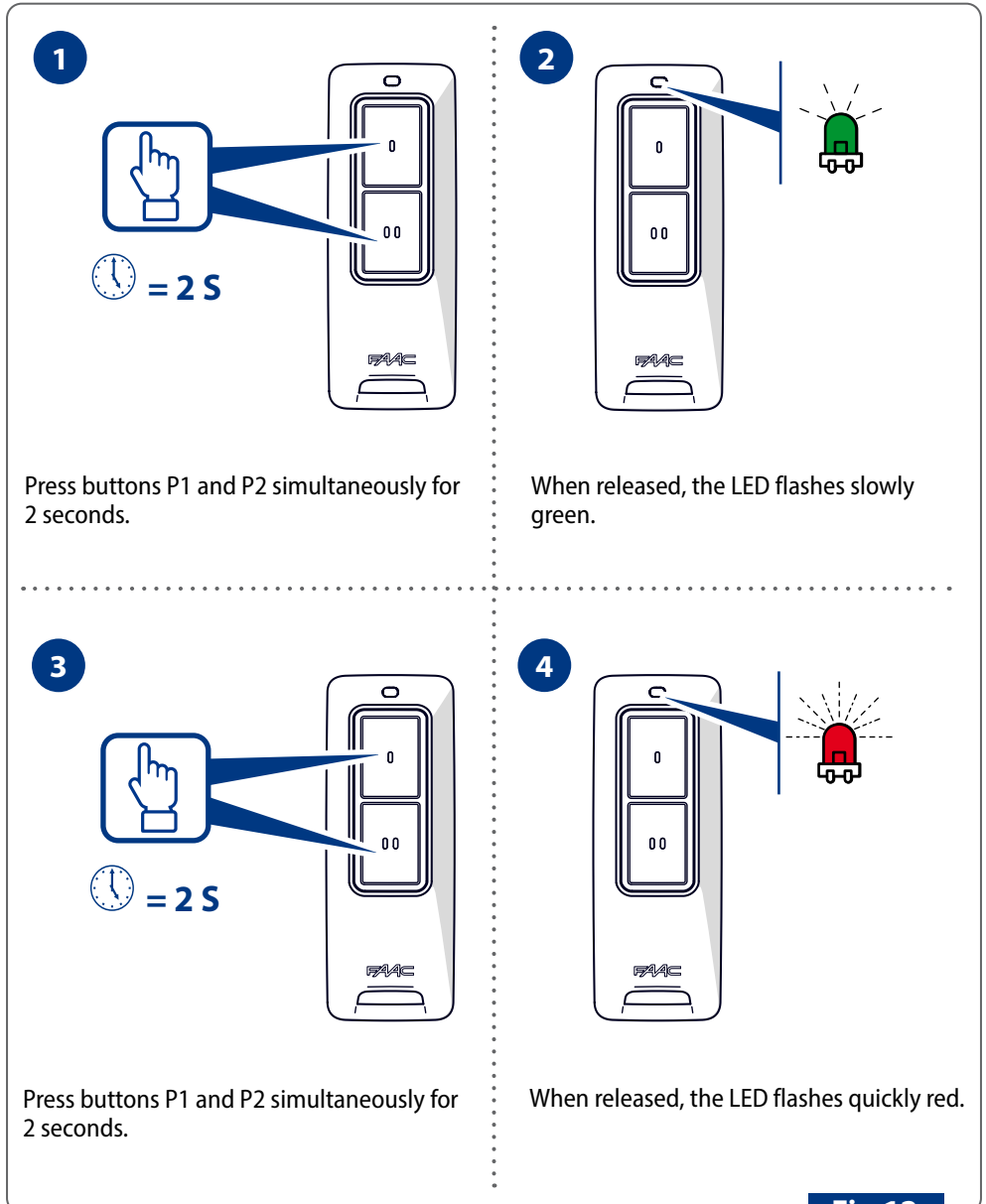
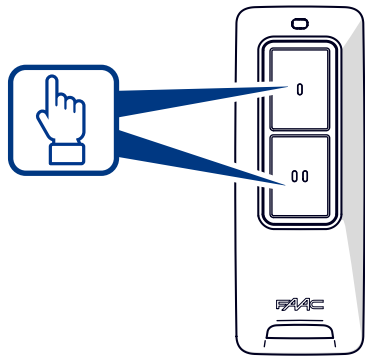
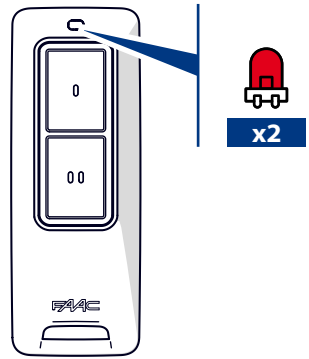

Fig.12

5



6



Press buttons P1 and P2 in the following sequence:

1. P1
2. P2
3. P1

If the procedure has been carried out correctly, the LED turns on steady red for 5 seconds.

Fig.13

6. MAINTENANCE

6.1 REPLACING THE BATTERIES



If the LED flashes red when you press any button on the remote control, it means that the battery is low and should be replaced.

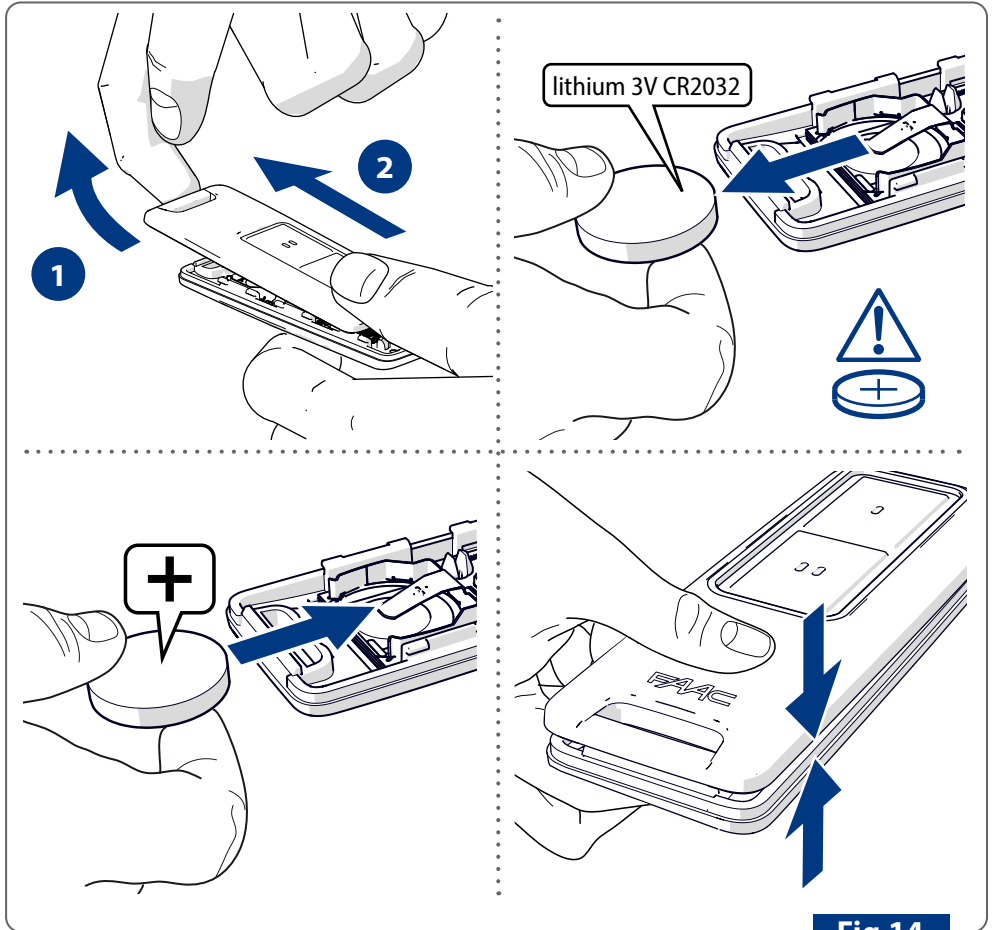

Fig.14



This product contains a button cell battery. If the button cell battery is swallowed, it can cause severe internal burns in as little as 2 hours and can lead to death.

FAAC

FAAC S.p.A. Soc. Unipersonale

Via Calari, 10 - 40069 Zola Predosa BOLOGNA - ITALY

Tel. +39 051 61724 - Fax +39 051 09 57 820

www.faac.it - www.faaotechnologies.com

